



*your reliable partner*

## ROBA®-DSM

The Torque Measuring  
Machine Element



## Construction and Development

### Innovations for Your Success

With our innovative and economical solutions, we are able to set new records in the field of power transmission. Our many worldwide patents prove our constant ambition to develop better and technologically superior products.

Highly qualified engineers, high-performance 3D-CAD-systems and the most up-to-date FEM calculation aids used in our Development and Construction departments mean that our business is perfectly equipped to offer our customers effective solutions.

### Experts for all Power Transmission Questions

Exploit our know-how, gained by decades of experience in the development, production and application of power transmission products. Our experts in Construction and Development are happy to advise you personally and competently when selecting and dimensioning the drive solution you require.

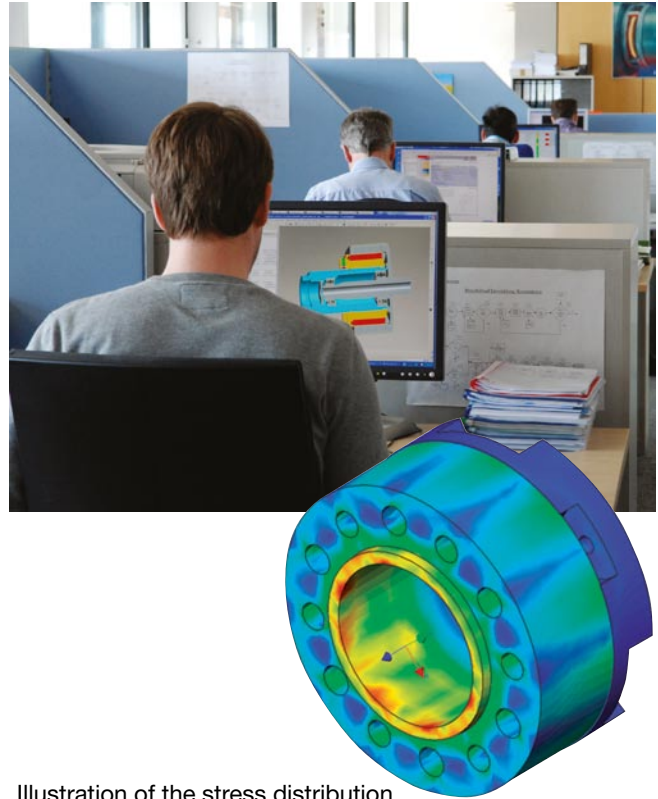

Illustration of the stress distribution in a backlash-free shaft connection

## From Prototype to Finished Product

***No mayr<sup>®</sup> product is released onto the market until it has proved its functional capabilities and reliability in extreme, long-term tests.***

The spectrum of testing stands is as varied as our range of products:

- Friction work test stands
- Wear test stands
- Noise measurement room with highly accurate noise measurement inspection devices
- Torque inspection stands up to 200.000 Nm
- Impact alternating load test stands
- Force test stands
- Linear movement test stands
- Continuous performance test stands
- Magnetic flow measurement test stands
- High-speed test stands up to 20.000 rpm
- Misalignment and angular misalignment test stands
- Load and measurement test stands for DC motors

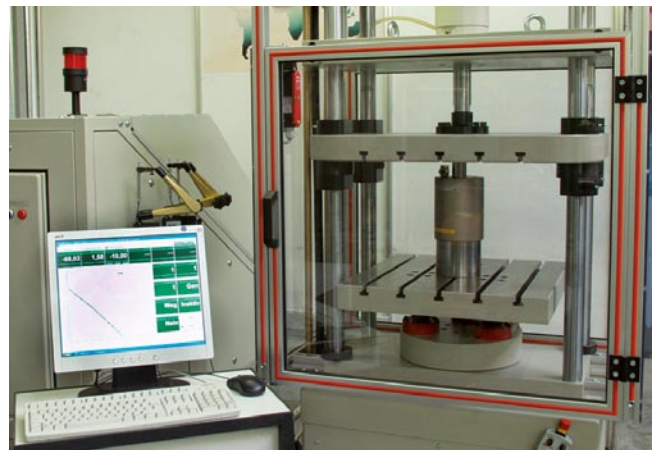

## Product Data: Our 24-hour Service

Our website offers you detailed information 24 hours per day, 365 days per year with no delays. Here you can find not only the latest catalogues and technical documentation but also CAD-files for cost-saving construction of our products.

## Unsurpassed - Our Standard Program

For safety clutches, safety brakes, backlash-free shaft couplings and high-quality DC drives, we offer you a complete product range with market and branch optimised constructions and designs.

## A Worldwide Presence

Our Sales and Service network is constantly expanding. We guarantee you and your customers local representation almost all over the world. With eight branch firms in France, Switzerland, Italy, England, Poland, the USA, Singapore and China as well as around 30 representatives and eight subsidiaries in Germany, we provide local service for our customers in all important industrial areas.



## Total Quality Management

### Product Quality

Every delivery which leaves our firm has been subjected to a careful quality inspection, meaning that you are able to rely 100 % on *mayr*<sup>®</sup> products. If required, we pre-adjust our clutches and brakes accurately to the requested values and confirm the product characteristics with an Inspection Report.

### Quality Management

*mayr*<sup>®</sup> uses the term quality to describe its products and services. Certification of our quality management confirms the quality-consciousness of our colleagues at every level of the company.

Our integrated management system is certified according to **DIN EN ISO 9001:2000 (Quality)** and **DIN EN ISO 14001 (Environment)** and complies with the **OHSAS 18001/OHRIS (Occupational Health and Safety)** demands.



## Individual and Flexible Logistics

Flexible and optimally qualified colleagues ensure that your order is delivered according to schedule and with the most appropriate delivery method. We take into account your individual packaging and dispatch regulations as a matter of course. Our modern high rack warehouse has a permanently available stock of our wide standard product selection.

And if you are really in a hurry, simply use our uniquely-quick basic product delivery service!

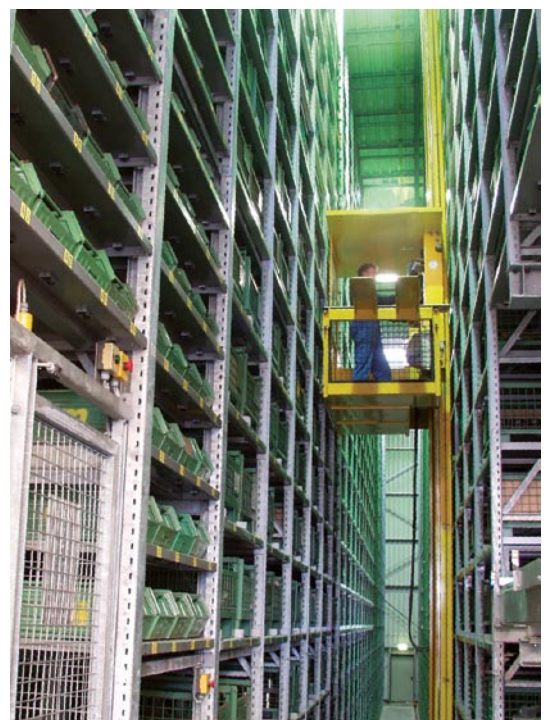

## ROBA®-DSM – the measuring machine element

The torque measuring shaft coupling ROBA®-DSM is based on the tried and tested backlash-free ROBA®-DS disk pack coupling. The areas of application for this torque measurement coupling range from test stand construction through use in serial production machines right up to condition monitoring. The system permits uncomplicated condition monitoring of machines and systems. Machines can be optimally utilised through evaluation of the coupling data.

### Valuable data for maximum productivity

The ROBA®-DSM monitors machines and records the measurement values<sup>1)</sup>. From this data, important information can be obtained for the user:

- Machine performance data
- Unpermitted operating conditions lying outside the specifications (in case of a defect or reclaim)
- Utilisation or runtime of the machine
- Current operating conditions and condition changes to the machine for preventative maintenance purposes
- Dynamic maintenance intervals dependent on the utilisation

### Highlights and system advantages

- Direct PC connection possible (USB connection)
- Software for visualisation of the measurement values available as an option
- Use without bearings
- Wide temperature range from -20 ° to +70 °
- Simple installation and set-up
- Low space requirements on the drive line, no torque support required
- Resistant to vibrations and distance changes on the energy transmitter
- Housing and plug-in connector suitable for industrial purposes (protected against water spray)
- High measuring rate of 7000 measurements per second permits the recording of highly-dynamic loads
- Operation of extension sensor without battery via contactless power supply

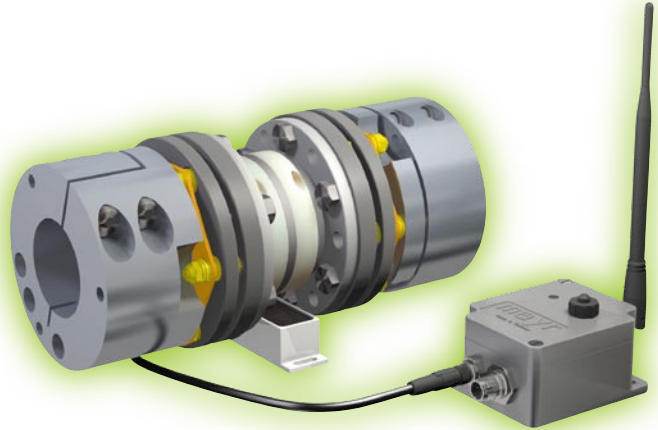

Fig. 1

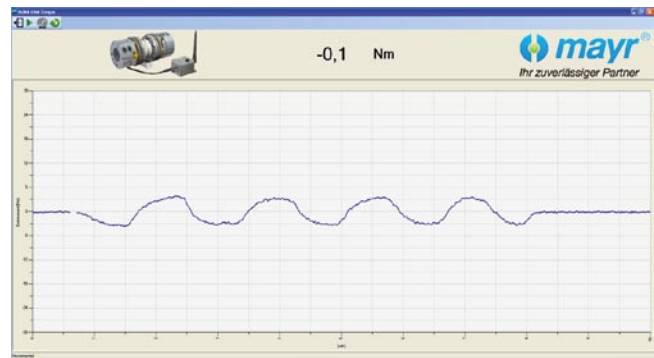

Fig. 2

### Order number

	HUB 1	HUB 2	
Key hub, standard (Fig. 7)	0	0	Key hub, standard (Fig. 7)
Key hub, large (Fig. 8)	1	1	Key hub, large (Fig. 8)
Shrink disk hub / external clamping (Fig. 9)	2	2	Shrink disk hub / external clamping (Fig. 9)
Clamping ring hub (Fig. 11)	4	4	Clamping ring hub (Fig. 11)
Clamping hub (Figs. 1, 3 and 12)	5	5	Clamping hub (Figs. 1, 3 and 12)
Flange (Fig. 13)	6	6	Flange (Fig. 13)
Split clamping hub <sup>3)</sup> (Fig. 14)	8	8	Split clamping hub <sup>3)</sup> (Fig. 14)
Shrink disk hub, large (Fig. 10)	9	9	Shrink disk hub, large (Fig. 10)

—	/	9	7	1	.	—	—	5	/	—	/	—
▲							▼	▼		▲		▲
<b>Sizes</b> 16 to 160							<b>Bore<sup>2)</sup></b> <b>Hub 1 ø</b> (See Dimensions sheets pages 8 – 9)			<b>Bore<sup>2)</sup></b> <b>Hub 2 ø</b> (See Dimensions sheets pages 8 – 9)		

**Example: 16 / 971.005 / Hub 1 – ø 25<sup>H7</sup> / Hub 2 – ø 30<sup>H7</sup>**

1) Recording of the measurement values possible only with the aid of appropriate software

2) Standard H7, other tolerances possible

3) For Type 971.885 (double-sided split clamping hub), radial installation/disassembly is not possible as the hubs are offset at an angle.

# ROBA®-DSM

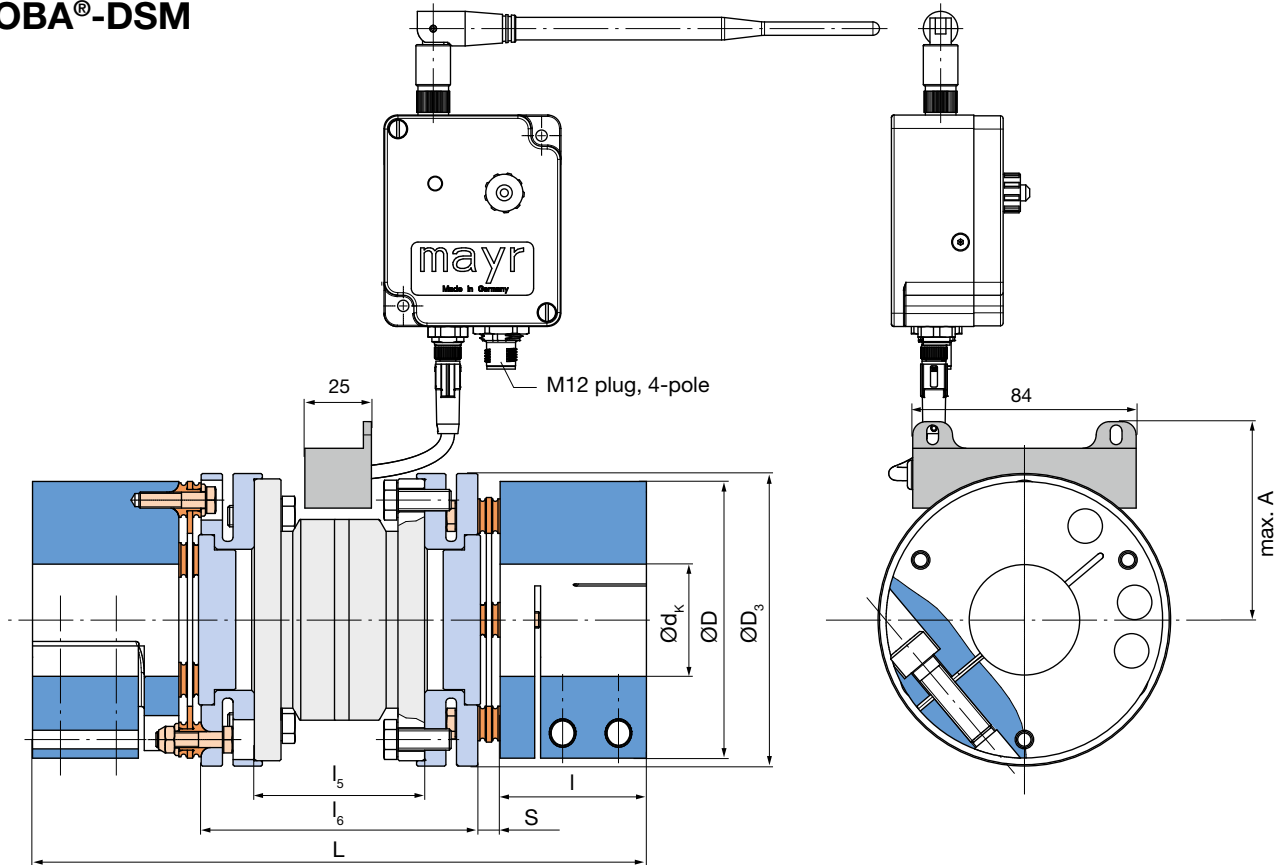

Fig. 3: Type 971.555 (for other mounting variants, see pages 7 – 9)

Technical data and main dimensions			Size				
			16	40	100	160	
Nominal torque <sup>1) 2)</sup>	$T_{KN}$	[Nm]	190	450	800	1600	
Peak torque <sup>3)</sup>	$T_{KS}$	[Nm]	285	675	1200	2400	
Ultimate torque	$T_{KB}$	[Nm]	570	1350	2400	4800	
Minimum hub bore Type 971.555 (Figs. 1 and 3) <sup>4) 5)</sup>	$d_{K\ min}$	[mm]	20	25	32	40	
Maximum hub bore Type 971.555 (Figs. 1 and 3) <sup>4) 5)</sup>	$d_{K\ max}$	[mm]	45	60	90	100	
Maximum speed	$n_{max}$	[rpm]	9500	7000	5100	4300	
Permitted misalignments <sup>6)</sup>	Permitted axial displacement <sup>7) 8)</sup>	$\Delta K_a$	[mm]	0,8	1,1	1,5	1,7
	Permitted angular misalignment <sup>9)</sup>	$\Delta K_w$	[mm]	0,7	0,7	0,7	0,7
	Permitted radial misalignment <sup>7)</sup>	$\Delta K_r$	[mm]	1,1	1,3	1,6	1,8
Spring rigidities	Total torsional rigidity		[10 <sup>3</sup> Nm/rad]	36,2	114,3	320	585
	Angular spring rigidity <sup>9)</sup>		[Nm/rad]	229	298	1089	1990

## Mass moments of inertia J [10<sup>-3</sup>kgm<sup>2</sup>]

	Size	16	40	100	160
Clamping hub <sup>5) 10)</sup>		0,74	3,64	16,94	34,32
Disk pack		0,08	0,26	1,19	3,27
Adaptor flange		0,38	1,67	7,06	15,36
Extension sensor		0,51	2,21	7,97	20,04

## Weights [kg]

	Size	16	40	100	160
Clamping hub <sup>5) 10)</sup>		0,73	2,05	4,82	6,94
Disk pack		0,08	0,15	0,35	0,67
Adaptor flange		0,43	1,11	2,44	3,89
Extension sensor		0,58	1,34	2,91	4,27

## Dimensions [mm]

	Size	16	40	100	160
A		55,5	63,7	74,3	87,5
D		77	104	143	167
D <sub>3</sub>		82	110	150	175
I <sup>5)</sup>		40	55	75	85
I <sub>5</sub>		54	64	72	78
I <sub>6</sub>		84	104	122	136
L <sup>5)</sup>		178,2	230,8	292	329,2
S		7,1	8,4	10	11,6

2) Valid for changing load direction as well as for max. permitted shaft misalignment. The following applies for split clamping hubs (Type 971.8\_5): Valid for unchanging load direction as well as for max. permitted shaft misalignment.

When the load direction changes, max. 60% of the stated nominal torque is permitted.

3) Valid for unchanging load direction, max. load cycles ≤ 10<sup>5</sup>.

4) Transmittable torques dependent on bore, see page 10.

5) For technical data on alternative mounting variations, see pages 8 – 9.

6) The permitted misalignments must not simultaneously reach their maximum values.

7) The values refer to couplings with 2 disk packs.

8) Only permitted as a static or virtually static value.

9) The values refer to 1 disk pack.

10) Mass moments of inertia and weights are valid for maximum bore.

1) Other torques and construction sizes available on request.

## ROBA®-DSM measuring system

### ROBA®-DSM receiver

The ROBA®-DSM receiver establishes the contactless connection to the extension sensor and supplies it with energy via the ROBA®-DSM stator.

### ROBA®-DSM stator

The stator must be aligned centrally to the extension sensor. The radial distance can total between 1 mm and 5 mm. After correct assembly, the LED on the ROBA®-DSM receiver lights up green and signals correct data transfer. The extension sensor is rotated slowly by 360° for inspection purposes.

If the LED lights up red at different angular positions, please select a different mounting place for the ROBA®-DSM receiver.

### Technical data

Supply voltage:	24 VDC ( $\pm 10\%$ )
Max. current consumption:	1 A
Measuring signal output:	0 ... $\pm 10$ V (rotational direction right positive, 10 V refers to $T_{KN}$ )
Nominal temperature range:	-20 °C to +70 °C
Temperature drift, zero point:	0,04 % of final value / K
Temperature drift, measured value:	0,03 % of final value / K
Max. total error:	< 1 % of final value
Bandwidth:	3 kHz (-3 dB)
Max. dyn. load:	100 % of $T_{KN}$
Protection:	Receiver / stator IP65 Extension sensor IP52
Permitted speed:	0 ... $n_{max}$ (Technical data, page 5)

### Electrical connection (Fig. 4)

- ❑ The ROBA®-DSM receiver is equipped manufacturer-side with a firmly installed 4-pole, A-encoded M12 plug.
- ❑ The voltage supply takes place via Pin 1 = +24 V  $\pm 10\%$  and Pin 3 = GND.
- ❑ The output signal is provided to Pin 4 = Ua torque 0 ...  $\pm 10$  V and Pin 2 = GND
- ❑ The digital measurement data can be read into a PC directly via the USB port using the *mayr*®-software.
- ❑ The radio ID and the radio channel can be set and the offset compensation can be carried out via the USB port using the service software.

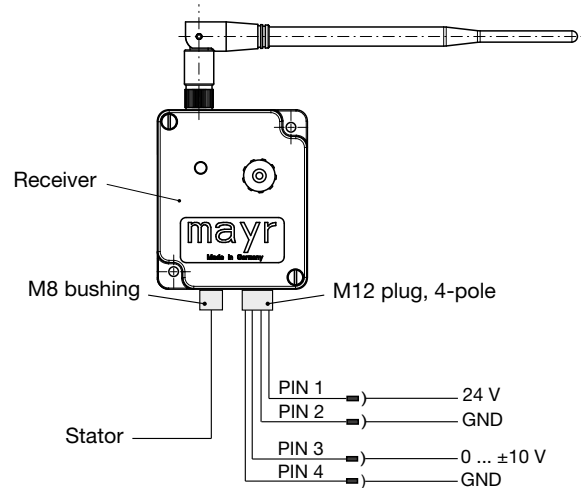

Fig. 4

### Detail drawing

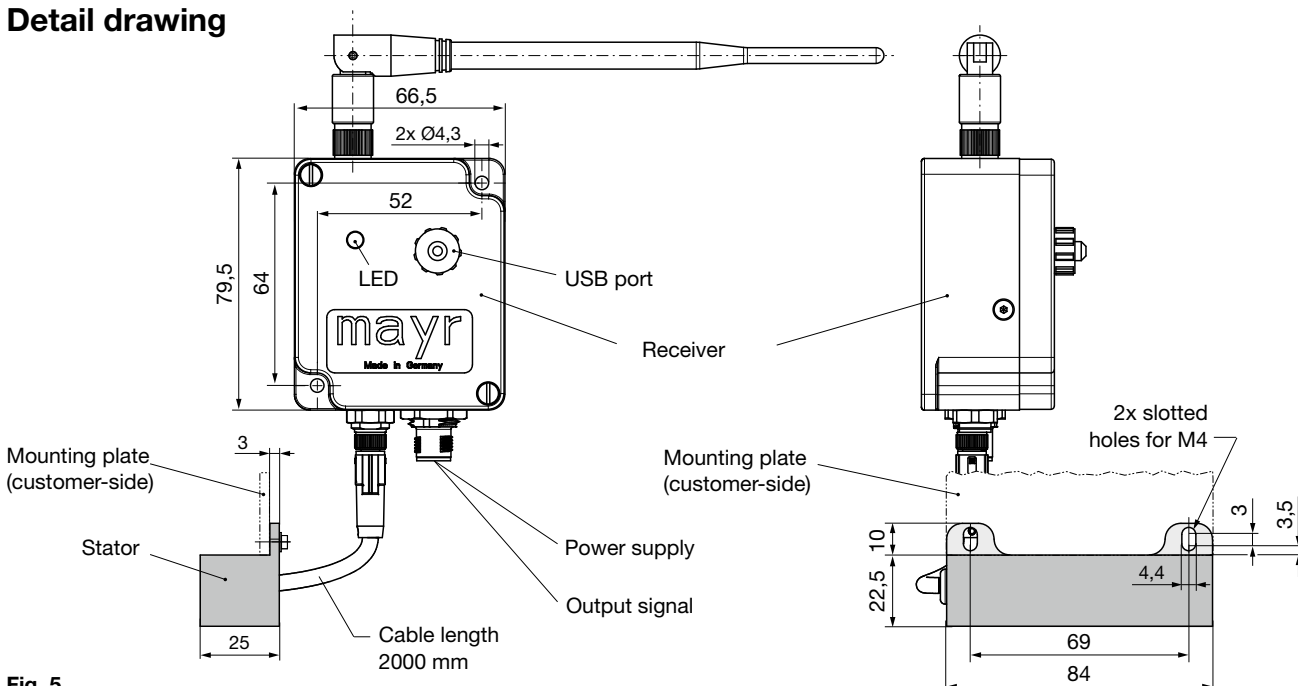

Fig. 5

## ROBA<sup>®</sup>-DSM configuration possibilities/standard designs

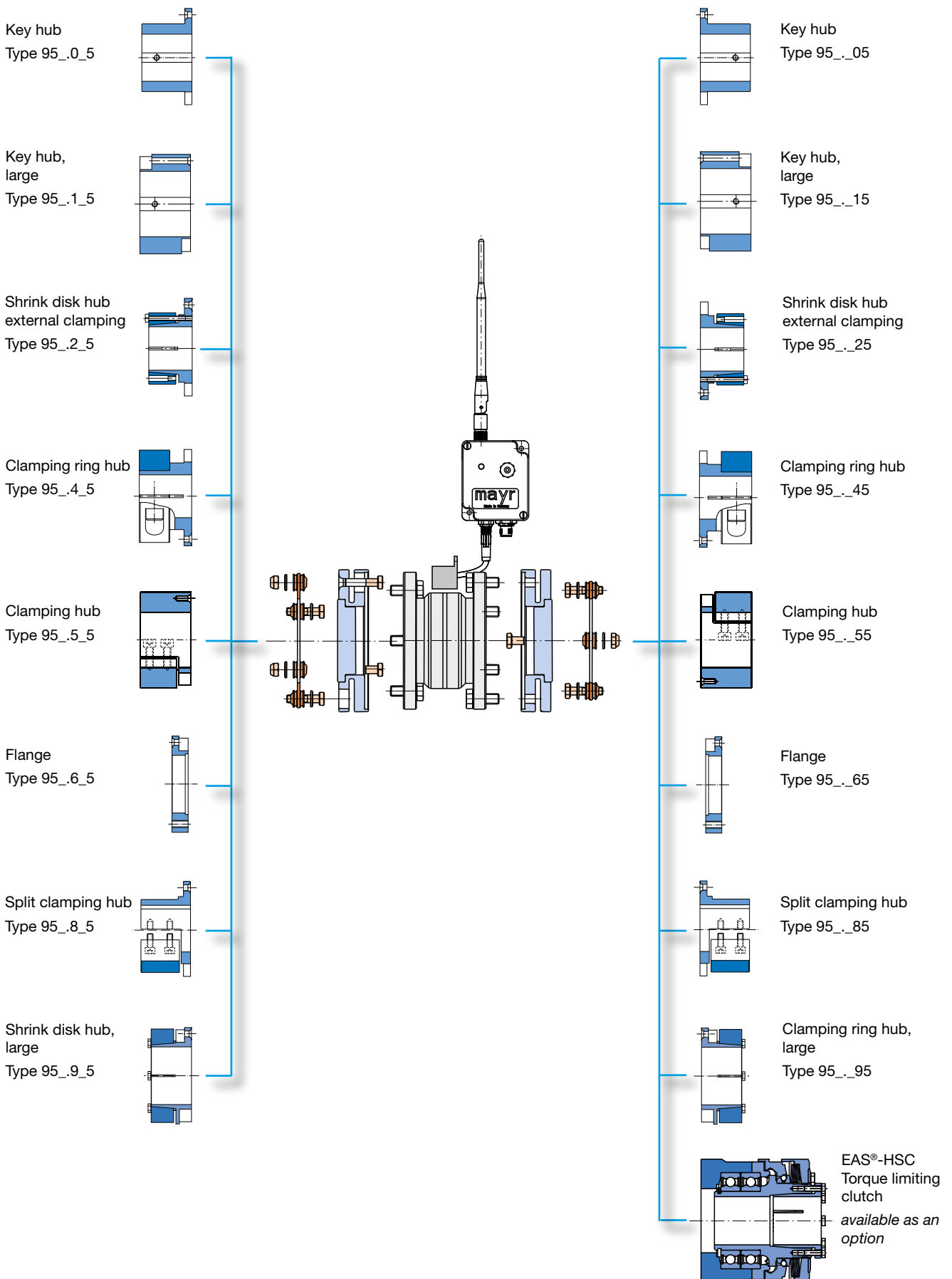

Fig. 6

## Key hub

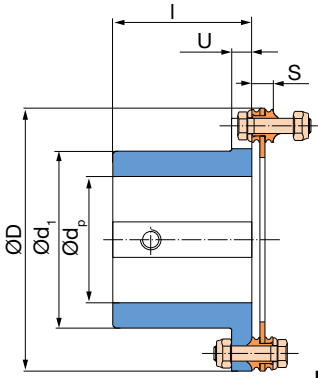

Fig. 7

### Dimensions [mm]

Size	16	40	100	160
$d_{p \min}$	16	25	35	40
$d_{p \max}$	32	50	70	80
D	77	104	143	167
$d_1$	50	70	100	115
L	178,2	230,8	292	329,2
I	40	55	75	85
S	7,1	8,4	10	11,6
U	7	8	10	12

### Mass moment of inertia J [ $10^{-3} \text{ kgm}^2$ ]

Size	16	40	100	160
Hub <sup>1)</sup>	0,27	1,16	6,18	12,51

### Weight [kg]

Size	16	40	100	160
Hub <sup>1)</sup>	0,46	1,02	2,83	4,25

1) Mass moment of inertia and weight are valid for maximum bore.

## Key hub, large

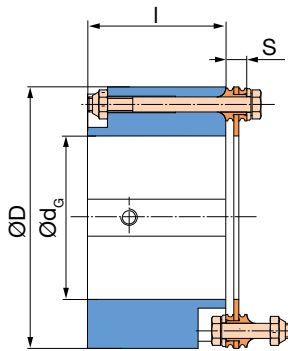

Fig. 8

### Dimensions [mm]

Size	16	40	100	160
$d_{G \min}$	30	45	65	75
$d_{G \max}$	45	65	95	110
D	77	104	143	167
L	178,2	230,8	292	329,2
I	40	55	75	85
S	7,1	8,4	10	11,6

### Mass moment of inertia J [ $10^{-3} \text{ kgm}^2$ ]

Size	16	40	100	160
Hub <sup>1)</sup>	0,86	3,89	18,12	36,00

### Weight [kg]

Size	16	40	100	160
Hub <sup>1)</sup>	0,87	2,08	4,94	7,23

1) Mass moment of inertia and weight are valid for maximum bore.

## Shrink disk hub / external clamping

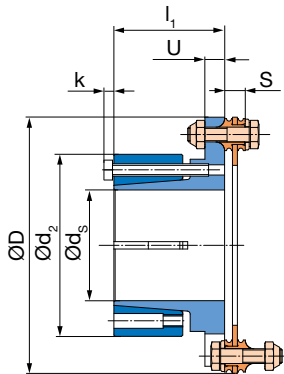

Fig. 9

### Dimensions [mm]

Size	16	40	100	160
$d_{S \min}^{2)}$	14	25	35	40
$d_{S \max}^{2)}$	26	45	55	65
D	77	104	143	167
$d_2$	53	74	104	118
k	3,5	3,5	5,5	5,5
L	168,2	210,8	252	279,2
$I_1$	35	45	55	60
S	7,1	8,4	10	11,6
U	7	8	10	12

### Mass moment of inertia J [ $10^{-3} \text{ kgm}^2$ ]

Size	16	40	100	160
Hub <sup>1)</sup>	0,27	1,15	5,59	11,14

### Weight [kg]

Size	16	40	100	160
Hub <sup>1)</sup>	0,49	1,03	2,73	3,99

1) Mass moment of inertia and weight are valid for maximum bore.

2) Transmittable torques dependent on bore, see page 10.

## Shrink disk hub, large

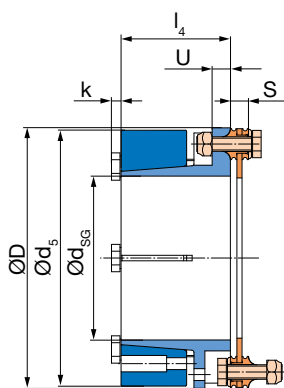

Fig. 10

### Dimensions [mm]

Size	16	40	100	160
$d_{SG \min}^{2)}$	25	40	55	65
$d_{SG \max}^{2)}$	45	60	90	100
D	77	104	143	167
$d_5$	77	100	143	162
k	3,5	3,5	5,5	5,5
L	178,2	220,8	262	299,2
$I_4$	40	50	60	70
S	7,1	8,4	10	11,6
U	7	8	10	12

### Mass moment of inertia J [ $10^{-3} \text{ kgm}^2$ ]

Size	16	40	100	160
Hub <sup>1)</sup>	0,78	2,88	13,77	27,35

### Weight [kg]

Size	16	40	100	160
Hub <sup>1)</sup>	0,79	1,71	3,92	6,08

1) Mass moment of inertia and weight are valid for maximum bore.

2) Transmittable torques dependent on bore, see page 10.



## Clamping ring hub

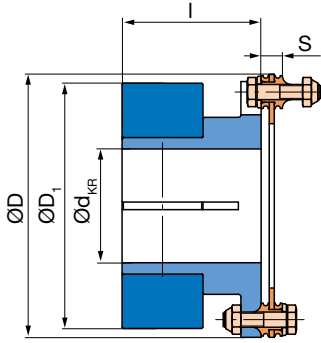

Fig. 11

### Dimensions [mm]

Size	16	40	100	160
$d_{KR \min}^{2)}$	20	25	32	40
$d_{KR \max}^{2)}$	35	45	68	80
D	77	104	143	167
D <sub>1</sub>	73	97	135	158
L	178,2	230,8	292	329,2
l	40	55	75	85
S	7,1	8,4	10	11,6

### Mass moment of inertia J [10<sup>-3</sup> kgm<sup>2</sup>]

Size	16	40	100	160
Hub <sup>1)</sup>	0,63	2,84	13,49	28,71

### Weight [kg]

Size	16	40	100	160
Hub <sup>1)</sup>	0,76	2,00	4,90	7,61

1) Mass moment of inertia and weight are valid for maximum bore.

2) Transmittable torques dependent on bore, see page 10.

## Clamping hub

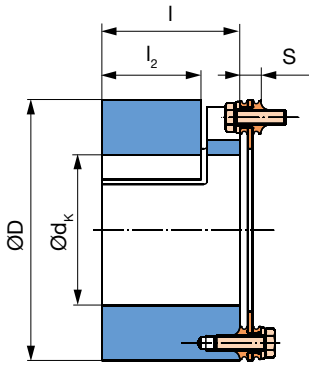

Fig. 12

### Dimensions [mm]

Size	16	40	100	160
$d_{K \min}^{2)}$	20	25	32	40
$d_{K \max}^{2)}$	45	60	90	100
D	77	104	143	167
L	178,2	230,8	292	329,2
l	40	55	75	85
l <sub>2</sub>	27	39,6	54,5	60
S	7,1	8,4	10	11,6

### Mass moment of inertia J [10<sup>-3</sup> kgm<sup>2</sup>]

Size	16	40	100	160
Hub <sup>1)</sup>	0,74	3,64	16,94	34,32

### Weight [kg]

Size	16	40	100	160
Hub <sup>1)</sup>	0,73	2,05	4,82	6,94

1) Mass moment of inertia and weight are valid for maximum bore.

2) Transmittable torques dependent on bore, see page 10.

## Flange

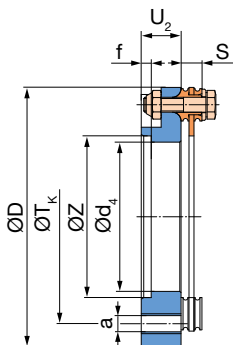

Fig. 13

### Dimensions [mm]

Size	16	40	100	160
Z <sup>H7</sup>	45	65	92	105
a	6 x M8	6 x M10	6 x M12	6 x M14
D	77	104	143	167
d <sub>4</sub>	40	60	85	100
f	4	4	5	5
L	128,2	156,8	182	215,2
S	7,1	8,4	10	11,6
T <sub>K</sub>	62	86	116	140
U <sub>2</sub>	15	18	20	28

### Mass moment of inertia J [10<sup>-3</sup> kgm<sup>2</sup>]

Size	16	40	100	160
Flange <sup>1)</sup>	0,23	0,89	3,87	9,48

### Weight [kg]

Size	16	40	100	160
Flange <sup>1)</sup>	0,26	0,52	1,16	2,10

1) Mass moment of inertia and weight are valid for maximum bore.

## Split clamping hub

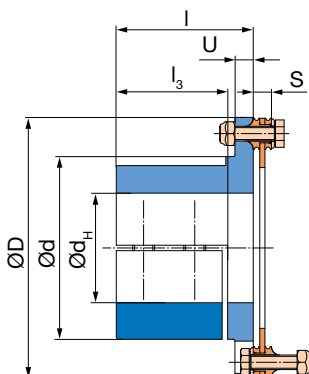

Fig. 14

### Dimensions [mm]

Size	16	40	100	160
$d_{H \min}^{2) 3)}$	18	25	35	40
$d_{H \max}^{2) 3)}$	28	40	60	75
D	77	104	143	167
d	50	70	100	115
L	178,2	230,8	292	329,2
l	40	55	75	85
l <sub>3</sub>	31	43	61	69
S	7,1	8,4	10	11,6
U	7	8	10	12

### Mass moment of inertia J [10<sup>-3</sup> kgm<sup>2</sup>]

Size	16	40	100	160
Hub <sup>1)</sup>	0,25	1,20	6,31	12,49

### Weight [kg]

Size	16	40	100	160
Hub <sup>1)</sup>	0,47	1,21	3,17	4,45

1) Mass moment of inertia and weight are valid for maximum bore.

2) Transmittable torques dependent on bore, see page 10.

3) Optional keyway design according to DIN 6885 possible.

**Frictionally locking transmittable torques of shrink disk hubs, clamping ring hubs, clamping hubs and split clamping hubs – dependent on bore**

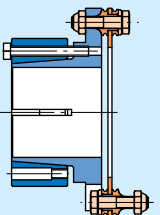
Shrink disk hubs		Bore	Size			
			16	40	100	160
 <p>Frictionally locking transmittable torques</p> <p><b>Shrink disk hubs</b></p> <p>Suitable for H7 / g6</p>	T <sub>R</sub> [Nm]	Ø14	157	-	-	-
		Ø16	179	-	-	-
		Ø20	240	-	-	-
		Ø22	269	-	-	-
		Ø25	312	438	-	-
		Ø28	-	491	-	-
		Ø30	-	526	-	-
		Ø32	-	600	-	-
		Ø35	-	669	1090	-
		Ø38	-	741	1184	-
		Ø40	-	796	1246	1794
		Ø42	<b>Caution!</b>	852	1320	1884
		Ø45	<b>Observe</b>	932	1500	2019
		Ø50	<b>permitted</b>	-	1692	2400
		Ø55	<b>peak torques</b>	-	1889	2680
		Ø60	<b>for selected</b>	-	-	2967
		Ø65	<b>coupling size</b>	-	-	3263

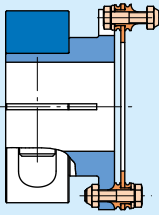
Clamping ring hubs		Bore	Size			
			16	40	100	160
 <p>Frictionally locking transmittable torques</p> <p><b>Clamping ring hubs</b></p> <p>Suitable for H7 / g6</p>	T <sub>R</sub> [Nm]	Ø20	126	-	-	-
		Ø22	138	-	-	-
		Ø25	168	327	-	-
		Ø28	201	366	-	-
		Ø30	216	420	-	-
		Ø32	230	470	785	-
		Ø35	251	515	859	-
		Ø38	-	559	932	-
		Ø40	-	588	1050	1256
		Ø45	-	661	1240	1413
		Ø50	-	-	1378	1680
		Ø55	<b>Caution!</b>	-	1516	1940
		Ø60	<b>Observe</b>	-	1654	2117
		Ø65	<b>permitted</b>	-	1792	2293
		Ø68	<b>peak torques</b>	-	1874	2399
		Ø70	<b>for selected</b>	-	-	2470
		Ø80	<b>coupling size</b>	-	-	2822

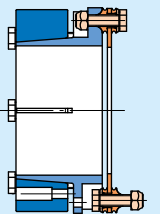
Shrink disk hubs, large		Bore	Size			
			16	40	100	160
 <p>Frictionally locking transmittable torques</p> <p><b>Shrink disk hubs, large</b></p> <p>Suitable for H7 / g6</p>	T <sub>R</sub> [Nm]	Ø25	339	-	-	-
		Ø28	404	-	-	-
		Ø30	448	-	-	-
		Ø32	492	-	-	-
		Ø35	558	-	-	-
		Ø38	620	-	-	-
		Ø40	659	873	-	-
		Ø42	694	937	-	-
		Ø45	738	1036	-	-
		Ø48	-	1132	-	-
		Ø50	-	1195	-	-
		Ø52	-	1255	-	-
		Ø55	-	1338	2074	-
		Ø60	-	1454	2366	-
		Ø65	-	-	2658	3246
		Ø70	<b>Caution!</b>	-	2943	3618
		Ø75	<b>Observe</b>	-	3213	3991
		Ø80	<b>permitted</b>	-	3458	4353
		Ø85	<b>peak torques</b>	-	3666	4695
		Ø90	<b>for selected</b>	-	3828	5007
Ø100	<b>coupling size</b>	-	-	5497		

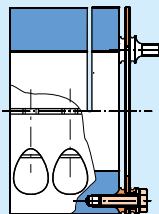
Clamping hubs		Bore	Size			
			16	40	100	160
 <p>Frictionally locking transmittable torques</p> <p><b>Clamping hubs</b></p> <p>Suitable for H7 / g6</p>	T <sub>R</sub> [Nm]	Ø20	183	-	-	-
		Ø22	202	-	-	-
		Ø25	229	604	-	-
		Ø28	257	677	-	-
		Ø30	275	725	-	-
		Ø32	293	773	1102	-
		Ø35	321	846	1205	-
		Ø38	348	918	1309	-
		Ø40	367	967	1378	1839
		Ø42	385	1015	1447	1931
		Ø45	412	1087	1550	2069
		Ø48	-	1160	1653	2207
		Ø50	-	1208	1722	2299
		Ø52	-	1257	1791	2391
		Ø55	-	1329	1894	2529
		Ø60	-	1450	2066	2759
		Ø65	-	-	2239	2989
		Ø68	-	-	2342	3127
		Ø70	-	-	2411	3219
		Ø75	<b>Caution!</b>	-	2583	3449
Ø80	<b>Observe</b>	-	2755	3679		
Ø85	<b>permitted</b>	-	2927	3909		
Ø90	<b>peak torques</b>	-	3100	4139		
Ø95	<b>for selected</b>	-	-	4369		
Ø100	<b>coupling size</b>	-	-	4599		

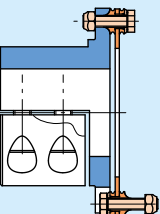
Split clamping hubs, large		Bore	Size			
			16	40	100	160
 <p>Frictionally locking transmittable torques</p> <p><b>Split clamping hubs</b></p> <p>Suitable for H7 / g6</p>	T <sub>R</sub> [Nm]	Ø18	130	-	-	-
		Ø20	144	-	-	-
		Ø22	158	-	-	-
		Ø25	180	326	-	-
		Ø28	202	365	-	-
		Ø30	-	391	-	-
		Ø32	-	418	-	-
		Ø35	-	457	897	-
		Ø38	-	496	973	-
		Ø40	-	522	1025	1218
		Ø42	-	-	1076	1279
		Ø45	-	-	1153	1370
		Ø50	-	-	1281	1522
		Ø55	<b>Caution!</b>	-	1409	1675
		Ø60	<b>Observe</b>	-	1537	1827
		Ø65	<b>permitted</b>	-	-	1979
		Ø68	<b>peak torques</b>	-	-	2071
Ø70	<b>for selected</b>	-	-	2131		
Ø75	<b>coupling size</b>	-	-	2284		

## Product Summary

### Safety Clutches/Overload Clutches

- **EAS®-Compact®/EAS®-NC**  
Positive locking and completely backlash-free torque limiting clutches
- **EAS®-smartic®**  
Cost-effective torque limiting clutches, quick installation
- **EAS®-element clutch/EAS®-elements**  
Load-disconnecting protection against high torques
- **EAS®-axial**  
Exact limitation of tensile and compressive forces
- **EAS®-Sp/EAS®-Sm/EAS®-Zr**  
Load-disconnecting torque limiting clutches with switching function
- **ROBA®-slip hub**  
Load-holding, frictionally locked torque limiting clutches
- **ROBA®-contitorque**  
Magnetic continuous slip clutches



### Shaft Couplings

- **smartflex®**  
Perfect precision couplings for servo and stepping motors
- **ROBA®-ES**  
Backlash-free and damping for vibration-sensitive drives
- **ROBA®-DS/ROBA®-D**  
Backlash-free, torsionally rigid all-steel couplings
- **EAS®-control-DS**  
Cost-effective torque-measuring couplings

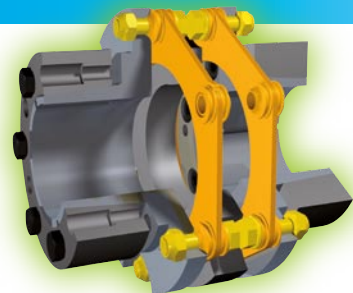

### Electromagnetic Brakes/Clutches

- **ROBA-stop® standard**  
Multifunctional all-round safety brakes
- **ROBA-stop®-M motor brakes**  
Robust, cost-effective motor brakes
- **ROBA-stop®-S**  
Water-proof, robust monoblock brakes
- **ROBA-stop®-Z/ROBA-stop®-silenzio®**  
Doubly safe elevator brakes
- **ROBA®-diskstop®**  
Compact, very quiet disk brakes
- **ROBA®-topstop®**  
Brake systems for gravity loaded axes
- **ROBA®-linearstop**  
Backlash-free brake systems for linear motor axes
- **ROBATIC®/ROBA®-quick/ROBA®-takt**  
Electromagnetic clutches and brakes, clutch brake units

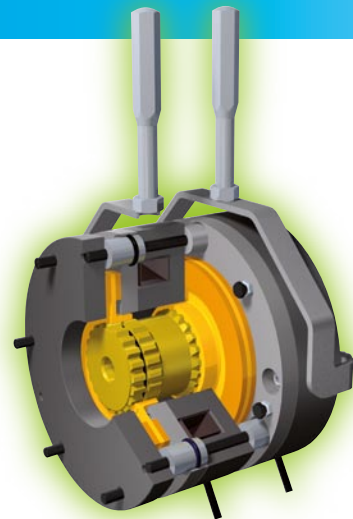

### DC Drives

- **tendo®-PM**  
Permanent magnet-excited DC motors
- **tendo®-SC**  
1 quadrant and 4 quadrant transistor controllers

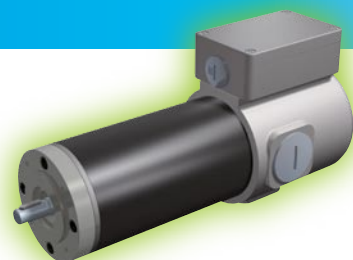

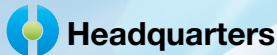

## Headquarters

**Chr. Mayr GmbH + Co. KG**  
**Eichenstrasse 1, D-87665 Mauerstetten**  
**Tel.: +49 83 41/8 04-0, Fax: +49 83 41/80 44 21**  
**www.mayr.com, E-Mail: info@mayr.com**



**your reliable partner**

## Service Germany

### Baden-Württemberg

Esslinger Straße 7  
 70771 Leinfelden-Echterdingen  
 Tel.: 07 11/45 96 01 0  
 Fax: 07 11/45 96 01 10

### Bavaria

Eichenstrasse 1  
 87665 Mauerstetten  
 Tel.: 0 83 41/80 41 04  
 Fax: 0 83 41/80 44 23

### Chemnitz

Bornaer Straße 205  
 09114 Chemnitz  
 Tel.: 03 71/4 74 18 96  
 Fax: 03 71/4 74 18 95

### Franken

Unterer Markt 9  
 91217 Hersbruck  
 Tel.: 0 91 51/81 48 64  
 Fax: 0 91 51/81 62 45

### Hagen

Im Langenstück 6  
 58093 Hagen  
 Tel.: 0 23 31/78 03 0  
 Fax: 0 23 31/78 03 25

### Kamen

Lünener Strasse 211  
 59174 Kamen  
 Tel.: 0 23 07/23 63 85  
 Fax: 0 23 07/24 26 74

### North

Schiefer Brink 8  
 32699 Extertal  
 Tel.: 0 57 54/9 20 77  
 Fax: 0 57 54/9 20 78

### Rhine-Main

Hans-Böckler-Straße 6  
 64823 Groß-Umstadt  
 Tel.: 0 60 78/7 82 53 37  
 Fax: 0 60 78/9 30 08 00

## Branch office

### China

Mayr Zhangjiagang  
 Power Transmission Co., Ltd.  
 Changxing Road No. 16,  
 215600 Zhangjiagang  
 Tel.: 05 12/58 91-75 65  
 Fax: 05 12/58 91-75 66  
 info@mayr-ptc.cn

### Great Britain

Mayr Transmissions Ltd.  
 Valley Road, Business Park  
 Keighley, BD21 4LZ  
 West Yorkshire  
 Tel.: 0 15 35/66 39 00  
 Fax: 0 15 35/66 32 61  
 sales@mayr.co.uk

### France

Mayr France S.A.  
 Z.A.L. du Minopole  
 Rue Nungesser et Coli  
 62160 Bully-Les-Mines  
 Tel.: 03.21.72.91.91  
 Fax: 03.21.29.71.77  
 contact@mayr.fr

### Italy

Mayr Italia S.r.l.  
 Viale Veneto, 3  
 35020 Saonara (PD)  
 Tel.: 0498/79 10 20  
 Fax: 0498/79 10 22  
 info@mayr-italia.it

### Singapore

Mayr Transmission (S) PTE Ltd.  
 No. 8 Boon Lay Way Unit 03-06,  
 TradeHub 21  
 Singapore 609964  
 Tel.: 00 65/65 60 12 30  
 Fax: 00 65/65 60 10 00  
 info@mayr.com.sg

### Switzerland

Mayr Kupplungen AG  
 Tobelackerstrasse 11  
 8212 Neuhausen am Rheinfall  
 Tel.: 0 52/6 74 08 70  
 Fax: 0 52/6 74 08 75  
 info@mayr.ch

### USA

Mayr Corporation  
 4 North Street  
 Waldwick  
 NJ 07463  
 Tel.: 2 01/4 45-72 10  
 Fax: 2 01/4 45-80 19  
 info@mayrcorp.com

## Representatives

### Australia

Regal Beloit Australia Pty Ltd.  
 19 Corporate Ave  
 03178 Rowville, Victoria  
 Australien  
 Tel.: 0 3/92 37 40 00  
 Fax: 0 3/92 37 40 80  
 salesAUvic@regalbeloit.com

### India

National Engineering  
 Company (NENCO)  
 J-225, M.I.D.C.  
 Bhosari Pune 411026  
 Tel.: 0 20/27 13 00 29  
 Fax: 0 20/27 13 02 29  
 nenco@nenco.org

### Japan

MATSUI Corporation  
 2-4-7 Azabudai  
 Minato-ku  
 Tokyo 106-8641  
 Tel.: 03/35 86-41 41  
 Fax: 03/32 24 24 10  
 k.goto@matsui-corp.co.jp

### Netherlands

Groneman BV  
 Amarilstraat 11  
 7554 TV Hengelo OV  
 Tel.: 074/2 55 11 40  
 Fax: 074/2 55 11 09  
 aandrijftechnik@groneman.nl

### Poland

Wamex Sp. z o.o.  
 ul. Pozaryskiego, 28  
 04-703 Warszawa  
 Tel.: 0 22/6 15 90 80  
 Fax: 0 22/8 15 61 80  
 wamex@wamex.com.pl

### South Korea

Mayr Korea Co. Ltd.  
 Room No.1002, 10th floor,  
 Nex Zone, SK TECHNOPARK,  
 77-1, SungSan-Dong,  
 SungSan-Gu, Changwon, Korea  
 Tel.: 0 55/2 62-40 24  
 Fax: 0 55/2 62-40 25  
 info@mayrkorea.com

### Taiwan

German Tech Auto Co., Ltd.  
 No. 28, Fenggong Zhong Road,  
 Shengang Dist.,  
 Taichung City 429, Taiwan R.O.C.  
 Tel.: 04/25 15 05 66  
 Fax: 04/25 15 24 13  
 abby@zfgta.com.tw

### Czech Republic

BMC - TECH s.r.o.  
 Hvězdoslavova 29 b  
 62700 Brno  
 Tel.: 05/45 22 60 47  
 Fax: 05/45 22 60 48  
 info@bmc-tech.cz

## More representatives:

Austria, Belgium, Brazil, Canada, Denmark, Finland, Greece, Hongkong, Hungary, Indonesia, Israel, Luxembourg, Malaysia, New Zealand, Norway, Philippines, Romania, Russia, Slovakia, Slovenia, South Africa, Spain, Sweden, Thailand, Turkey

You can find the complete address for the representative responsible for your area under [www.mayr.com](http://www.mayr.com) in the internet.