

TP+ / TP+ HIGH TORQUE – Compact precision



TP+

Compact top performers with output flange. The standard version is ideally suited for high positioning accuracy and highly dynamic cyclic operation. The TP+ HIGH TORQUE is particularly appropriate for high-precision applications in which high torsional rigidity is required.

TP+ compared to the industry standard

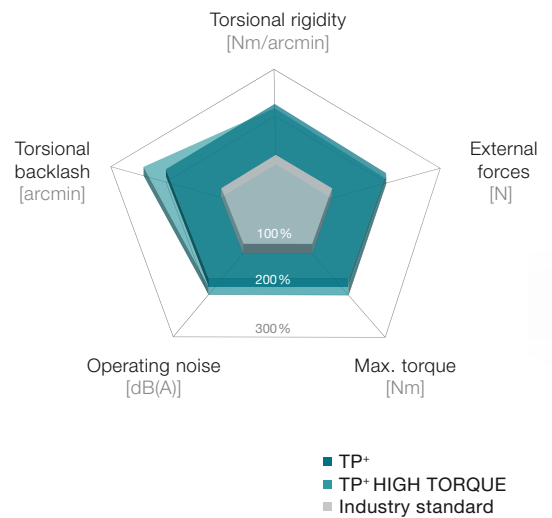

Product highlights

Max. torsional backlash [arcmin] ≤ 1 – 4

High torsional rigidity

Space-saving design

Flexible drive options

Clamping hub socket, optimized mass inertia, keyed clamping hub socket

Other gearbox models

Corrosion resistant design, food-grade lubrication



TP+ 2000 / 4000



TP+ in corrosion resistant design

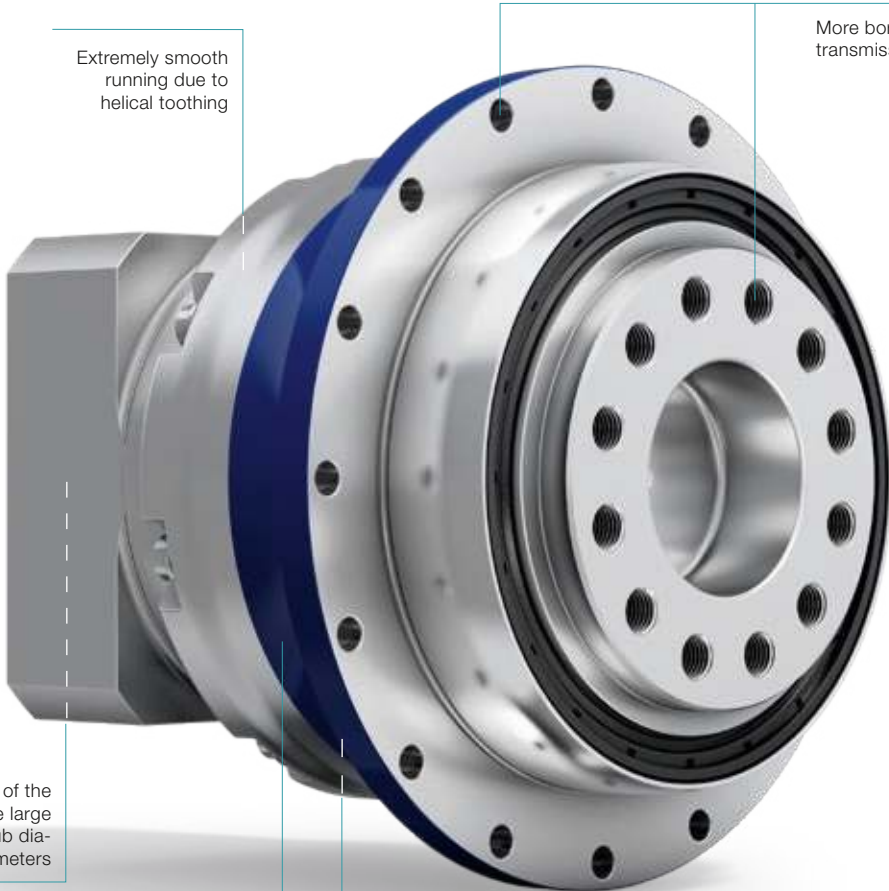

Extremely smooth running due to helical toothing

More bores for very high torque transmission

Connectivity of the motor shafts due to the large number of clamping hub diameters

Very high torque density due to superior toothing concept

TP+ HIGH TORQUE

Tapered roller bearing for absorbing axial and radial forces



TP+ HIGH TORQUE with rack and pinion



premo TP Line



TP+ with mounting ring (Further information pages 326 – 327)

TP+ 004 MF 1-stage

			1-stage						
Ratio	<i>i</i>		4	5	7	8	10		
Max. torque ^{a) b)}	T_{2a}	Nm	83	83	83	56	56		
		in.lb	735	735	735	496	496		
Max. acceleration torque ^{b)} (max. 1000 cycles per hour)	T_{2B}	Nm	66	66	66	42	42		
		in.lb	584	584	584	372	372		
Nominal torque (at n_n)	T_{2N}	Nm	27	27	26	26	27		
		in.lb	239	236	226	230	237		
Emergency stop torque ^{a) b)} (permitted 1000 times during the service life of the gearbox)	T_{2Not}	Nm	100	100	100	100	100		
		in.lb	885	885	885	885	885		
Permitted average input speed (at T_{2a} and 20 °C ambient temperature) ^{d)}	n_{1N}	rpm	3300	3300	4000	4000	4000		
Max. input speed	n_{1Max}	rpm	7500	7500	7500	7500	7500		
Mean no load running torque ^{b)} (at $n_i = 3000$ rpm and 20 °C gearbox temperature)	T_{012}	Nm	0.56	0.48	0.37	0.37	0.31		
		in.lb	5.0	4.2	3.3	3.3	2.7		
Max. backlash	j_t	arcmin	Standard ≤ 4 / Reduced ≤ 2						
Torsional rigidity ^{b)}	C_{t21}	Nm/arcmin	12	12	11	8	8		
		in.lb/arcmin	106	106	97	71	71		
Tilting rigidity	C_{2K}	Nm/arcmin	85						
		in.lb/arcmin	752						
Max. axial force ^{c)}	F_{2AMax}	N	2119						
		lb _f	477						
Max. tilting moment	M_{2KMax}	Nm	110						
		in.lb	974						
Efficiency at full load	η	%	97						
Service life	L_h	h	> 20000						
Weight (incl. standard adapter plate)	m	kg	1.4						
		lb _m	3.1						
Operating noise (at reference ratio and reference speed – ratio-specific values available in cymex [®])	L_{PA}	dB(A)	≤ 55						
			+90						
Max. permitted housing temperature		°C	+90						
		F	194						
Ambient temperature		°C	-15 to +40						
		F	5 to 104						
Lubrication			Lubricated for life						
Direction of rotation			In- and output same direction						
Protection class			IP 65						
Metal bellows coupling (recommended product type – validate sizing with cymex [®])			BCT-00015AAX-031.500						
Bore diameter of coupling on the application side		mm	X = 012.000 - 028.000						
Mass moment of inertia (relates to the drive) Clamping hub diameter [mm] Optimized mass inertia version available on request	B	11	J_1	kgcm ²	0.17	0.14	0.11	0.11	0.09
				10 ⁻³ in.lb.s ²	0.15	0.12	0.10	0.10	0.08
	C	14	J_1	kgcm ²	0.25	0.21	0.18	0.18	0.17
				10 ⁻³ in.lb.s ²	0.22	0.19	0.16	0.16	0.15
	E	19	J_1	kgcm ²	0.57	0.54	0.51	0.51	0.49
				10 ⁻³ in.lb.s ²	0.50	0.48	0.45	0.45	0.43

Please use our sizing software cymex[®] for a detailed sizing – www.wittenstein-cymex.com

^{a)} At max. 10 % M_{2KMax}

^{b)} Valid for standard clamping hub diameter

^{c)} Refers to center of the output shaft or flange

^{d)} Please reduce input speed at higher ambient temperatures

View A

View B

1-stage

up to 11⁴⁾ (B)
clamping hub diameter

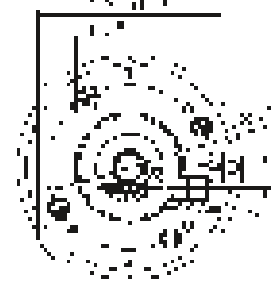
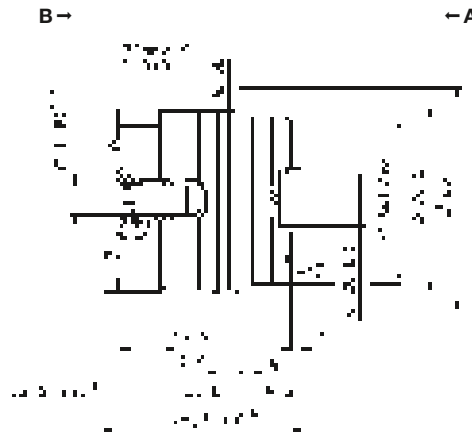
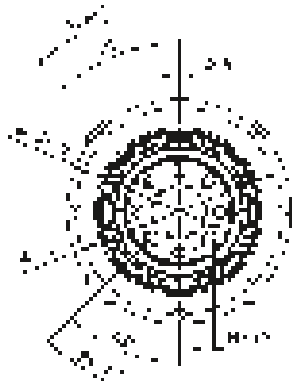

up to 14⁴⁾ (C)⁵⁾
clamping hub diameter

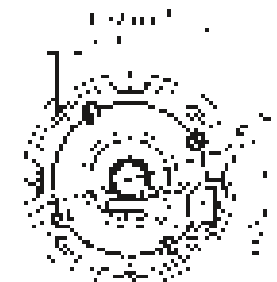
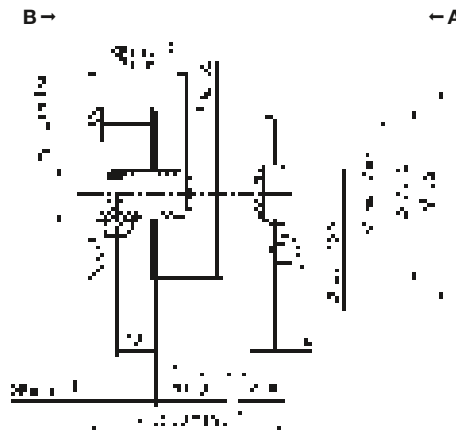
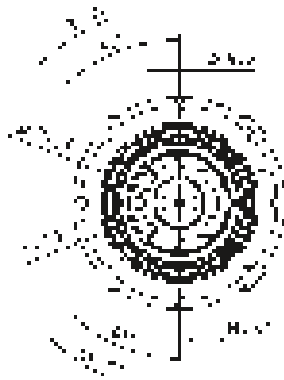

up to 19⁴⁾ (E)
clamping hub diameter

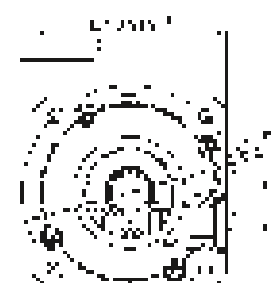
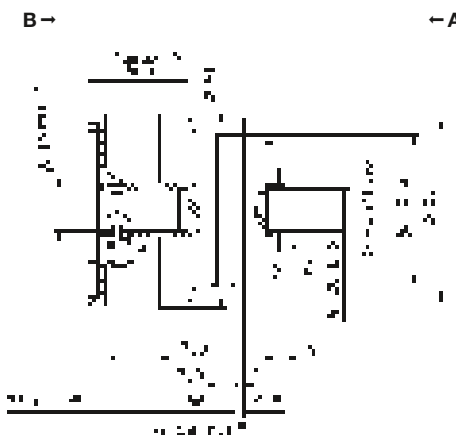
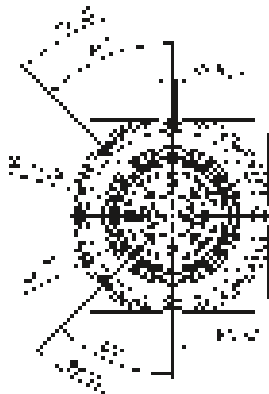

Motor shaft diameter [mm]

Planetary gearboxes

TP*

MF

Non-tolerated dimensions are nominal dimensions

¹⁾ Check motor shaft fit

²⁾ Min./Max. permissible motor shaft length. Longer motor shafts are possible, please contact alpha.

³⁾ The dimensions depend on the motor

⁴⁾ Smaller motor shaft diameter is compensated by a bushing with a minimum thickness of 1 mm

⁵⁾ Standard clamping hub diameter

TP+ 004 MF 2-stage

			2-stage																
Ratio	<i>i</i>		16	20	21	25	28	31	32	35	40	50	61	64	70	91	100		
Max. torque ^{a) b)}	T_{2a}	Nm	57	57	60	72	57	50	57	72	57	72	49	48	56	43	48		
		in.lb	507	507	533	634	507	442	507	634	507	634	435	423	499	385	423		
Max. acceleration torque ^{b)} (max. 1000 cycles per hour)	T_{2B}	Nm	57	57	48	66	57	48	57	66	57	66	49	42	56	38	42		
		in.lb	507	507	425	584	504	425	507	584	507	584	434	372	496	336	372		
Nominal torque (at n_n)	T_{2N}	Nm	39	41	32	41	45	36	39	45	46	48	39	34	45	31	34		
		in.lb	342	365	286	361	403	320	343	399	406	421	341	297	399	272	297		
Emergency stop torque ^{a) b)} (permitted 1000 times during the service life of the gearbox)	T_{2Not}	Nm	100	100	100	100	100	100	100	100	100	100	100	100	100	100	100		
		in.lb	885	885	885	885	885	885	885	885	885	885	885	885	885	885	885		
Permitted average input speed (at T_{2a} and 20 °C ambient temperature) ^{d)}	n_{1N}	rpm	4000	4000	4000	4000	4000	4000	4000	4000	4000	4800	5500	4800	5500	5500	5500		
Max. input speed	n_{1Max}	rpm	7500	7500	7500	7500	7500	7500	7500	7500	7500	7500	7500	7500	7500	7500	7500		
Mean no load running torque ^{b)} (at $n_1 = 3000$ rpm and 20 °C gearbox temperature)	T_{012}	Nm	0.28	0.23	0.24	0.22	0.21	0.22	0.21	0.17	0.18	0.17	0.16	0.17	0.17	0.15	0.16		
		in.lb	2.5	2.0	2.1	1.9	1.9	1.9	1.9	1.5	1.6	1.5	1.4	1.5	1.5	1.3	1.4		
Max. backlash	j_t	arcmin	Standard ≤ 4 / Reduced ≤ 2																
Torsional rigidity ^{b)}	C_{t21}	Nm/arcmin	12	12	10	12	12	9	12	12	11	12	9	12	11	7	8		
		in.lb/arcmin	106	106	89	106	106	80	106	106	97	106	80	106	97	62	71		
Tilting rigidity	C_{2K}	Nm/arcmin	85																
		in.lb/arcmin	752																
Max. axial force ^{c)}	F_{2AMax}	N	2119																
		lb _f	477																
Max. tilting moment	M_{2KMax}	Nm	110																
		in.lb	974																
Efficiency at full load	η	%	94																
Service life	L_h	h	> 20000																
Weight (incl. standard adapter plate)	m	kg	1.5																
		lb _m	3.3																
Operating noise (at reference ratio and reference speed – ratio-specific values available in cymex [®])	L_{PA}	dB(A)	≤ 54																
Max. permitted housing temperature		°C	+90																
		F	194																
Ambient temperature		°C	-15 to +40																
		F	5 to 104																
Lubrication			Lubricated for life																
Direction of rotation			In- and output same direction																
Protection class			IP 65																
Metal bellows coupling (recommended product type – validate sizing with cymex [®])			BCT-00015AAX-031.500																
Bore diameter of coupling on the application side		mm	X = 012.000 - 028.000																
Mass moment of inertia (relates to the drive) Clamping hub diameter [mm] Optimized mass inertia version available on request	B	11	J_1	kgcm ²	0.078	0.070	0.074	0.068	0.062	0.072	0.062	0.061	0.057	0.057	0.058	0.060	0.056	0.057	0.056
				10 ⁻³ in.lb.s ²	0.069	0.062	0.065	0.060	0.055	0.064	0.055	0.054	0.050	0.050	0.051	0.053	0.050	0.050	0.050
	C	14	J_1	kgcm ²	0.17	0.17	0.17	0.16	0.16	0.17	0.16	0.16	0.15	0.15	0.15	0.16	0.15	0.15	0.15
				10 ⁻³ in.lb.s ²	0.15	0.15	0.15	0.15	0.14	0.15	0.14	0.14	0.14	0.14	0.14	0.14	0.14	0.13	0.14

Please use our sizing software cymex[®] for a detailed sizing – www.wittenstein-cymex.com

^{a)} At max. 10 % M_{2KMax}

^{b)} Valid for standard clamping hub diameter

^{c)} Refers to center of the output shaft or flange

^{d)} Please reduce input speed at higher ambient temperatures

View A

View B

2-stage

up to 11⁴⁾ (B)⁵⁾
clamping hub diameter

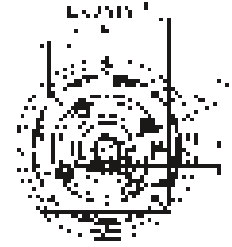
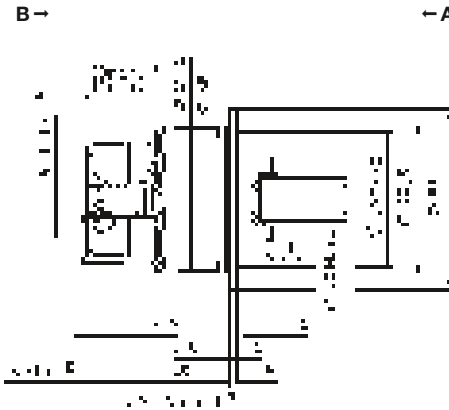
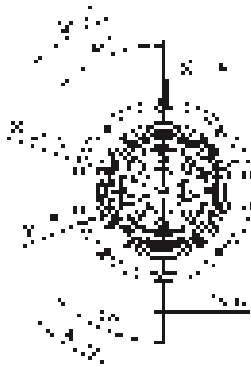

Motor shaft diameter [mm]

up to 14⁴⁾ (C)
clamping hub diameter

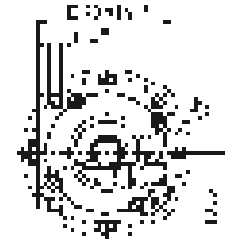
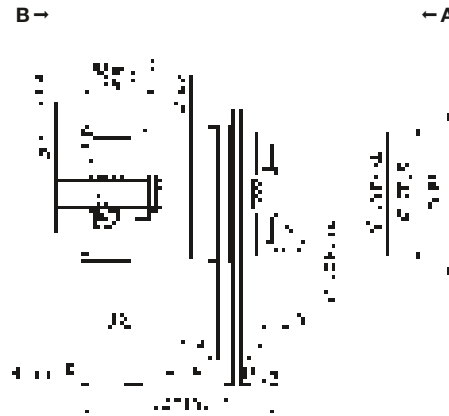
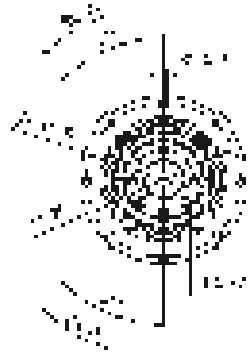

Planetary gearboxes

TP+

MF

Non-tolerated dimensions are nominal dimensions

¹⁾ Check motor shaft fit

²⁾ Min./Max. permissible motor shaft length. Longer motor shafts are possible, please contact alpha.

³⁾ The dimensions depend on the motor

⁴⁾ Smaller motor shaft diameter is compensated by a bushing with a minimum thickness of 1 mm

⁵⁾ Standard clamping hub diameter

TP+ 010 MF 1-stage

			1-stage						
Ratio	<i>i</i>		4	5	7	8	10		
Max. torque ^{a) b)}	T_{2a}	Nm	185	210	210	168	168		
		in.lb	1640	1859	1859	1487	1487		
Max. acceleration torque ^{b)} (max. 1000 cycles per hour)	T_{2B}	Nm	172	172	172	126	126		
		in.lb	1522	1522	1522	1115	1115		
Nominal torque (at n_n)	T_{2N}	Nm	84	81	81	80	81		
		in.lb	743	716	719	712	720		
Emergency stop torque ^{a) b)} (permitted 1000 times during the service life of the gearbox)	T_{2Not}	Nm	250	250	251	251	251		
		in.lb	2213	2213	2222	2222	2222		
Permitted average input speed (at T_{2a} and 20 °C ambient temperature) ^{d)}	n_{1N}	rpm	2600	2900	3100	3100	3100		
Max. input speed	n_{1Max}	rpm	7500	7500	7500	7500	7500		
Mean no load running torque ^{b)} (at $n_i = 3000$ rpm and 20 °C gearbox temperature)	T_{012}	Nm	1.3	1.1	0.84	0.84	0.64		
		in.lb	12	9.5	7.4	7.4	5.7		
Max. backlash	j_t	arcmin	Standard ≤ 4 / Reduced ≤ 2						
Torsional rigidity ^{b)}	C_{t21}	Nm/arcmin	32	33	30	23	23		
		in.lb/arcmin	283	292	266	204	204		
Tilting rigidity	C_{2K}	Nm/arcmin	225						
		in.lb/arcmin	1991						
Max. axial force ^{c)}	F_{2AMax}	N	2795						
		lb _f	629						
Max. tilting moment	M_{2KMax}	Nm	270						
		in.lb	2390						
Efficiency at full load	η	%	97						
Service life	L_h	h	> 20000						
Weight (incl. standard adapter plate)	m	kg	3.8						
		lb _m	8.4						
Operating noise (at reference ratio and reference speed – ratio-specific values available in cymex [®])	L_{PA}	dB(A)	≤ 57						
Max. permitted housing temperature		°C	+90						
		F	194						
Ambient temperature		°C	-15 to +40						
		F	5 to 104						
Lubrication			Lubricated for life						
Direction of rotation			In- and output same direction						
Protection class			IP 65						
Metal bellows coupling (recommended product type – validate sizing with cymex [®])			BCT-00060AAX-050.000						
Bore diameter of coupling on the application side		mm	X = 014.000 - 035.000						
Mass moment of inertia (relates to the drive) Clamping hub diameter [mm] Optimized mass inertia version available on request	C	14	J_1	kgcm ²	0.78	0.62	0.48	0.48	0.40
				10 ⁻³ in.lb.s ²	0.69	0.55	0.42	0.42	0.35
	E	19	J_1	kgcm ²	0.95	0.79	0.64	0.64	0.57
				10 ⁻³ in.lb.s ²	0.84	0.70	0.57	0.57	0.50
	G	24	J_1	kgcm ²	2.32	2.16	2.02	2.02	1.94
				10 ⁻³ in.lb.s ²	2.05	1.91	1.79	1.79	1.72

Please use our sizing software cymex[®] for a detailed sizing – www.wittenstein-cymex.com

^{a)} At max. 10 % M_{2KMax}

^{b)} Valid for standard clamping hub diameter

^{c)} Refers to center of the output shaft or flange

^{d)} Please reduce input speed at higher ambient temperatures

View A

View B

1-stage

up to 14⁴⁾ (C)
clamping hub
diameter

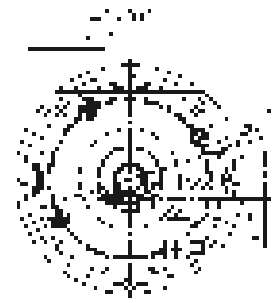
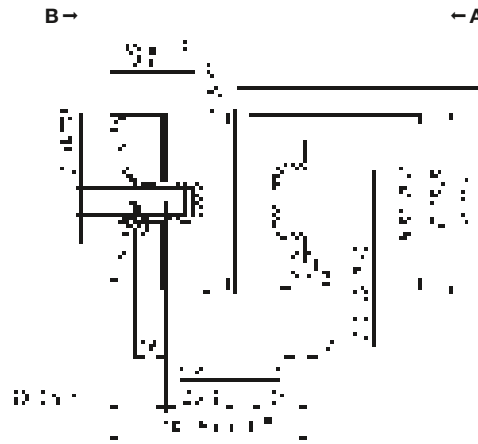
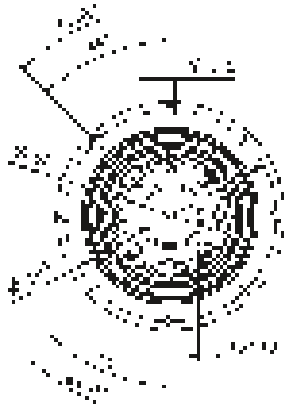

up to 19⁴⁾ (E)⁵⁾
clamping hub
diameter

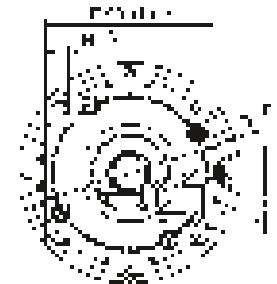
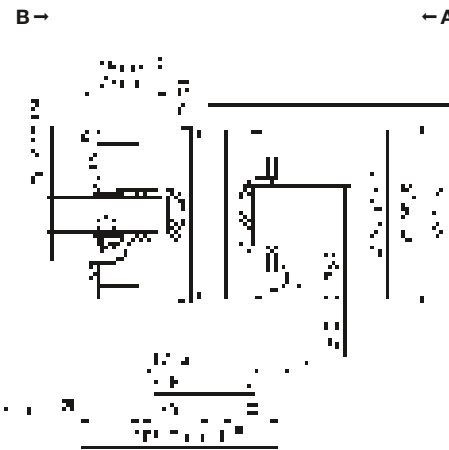
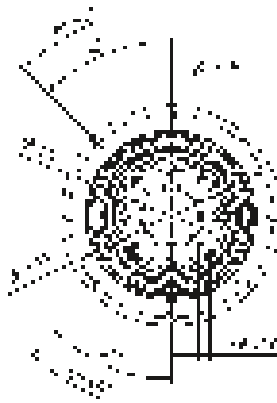

Motor shaft diameter [mm]

up to 24⁴⁾ (G)
clamping hub
diameter

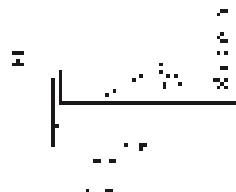
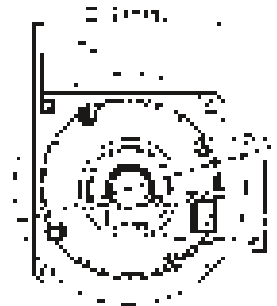
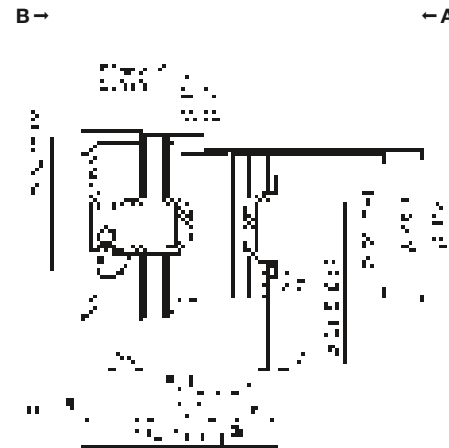
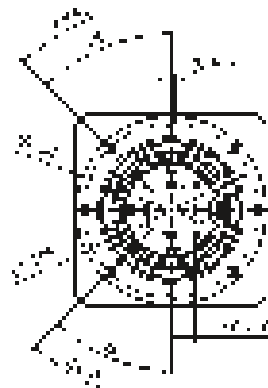

Planetary gearboxes

TP+
MF

Non-tolerated dimensions are nominal dimensions

¹⁾ Check motor shaft fit

²⁾ Min./Max. permissible motor shaft length. Longer motor shafts are possible, please contact alpha.

³⁾ The dimensions depend on the motor

⁴⁾ Smaller motor shaft diameter is compensated by a bushing with a minimum thickness of 1 mm

⁵⁾ Standard clamping hub diameter

TP+ 010 MF 2-stage

			2-stage															
Ratio	<i>i</i>		16	20	21	25	28	31	32	35	40	50	61	64	70	91	100	
Max. torque ^{a) b)}	T_{2a}	Nm	157	126	133	158	157	121	157	158	154	158	121	105	157	96	105	
		in.lb	1392	1118	1174	1398	1392	1071	1392	1398	1363	1398	1071	932	1392	848	932	
Max. acceleration torque ^{b)} (max. 1000 cycles per hour)	T_{2B}	Nm	157	126	120	158	157	121	157	158	154	158	121	105	157	96	105	
		in.lb	1392	1118	1062	1398	1392	1071	1392	1398	1363	1398	1071	932	1392	848	932	
Nominal torque (at n_n)	T_{2N}	Nm	106	101	96	124	107	87	119	126	112	126	97	84	126	77	84	
		in.lb	935	895	850	1097	945	770	1053	1118	987	1118	857	746	1114	678	746	
Emergency stop torque ^{a) b)} (permitted 1000 times during the service life of the gearbox)	T_{2Not}	Nm	251	251	251	251	251	251	251	251	251	251	251	251	251	251	251	
		in.lb	2222	2222	2222	2222	2222	2222	2222	2222	2222	2222	2222	2222	2222	2222	2222	
Permitted average input speed (at T_{2a} and 20 °C ambient temperature) ^{d)}	n_{1N}	rpm	3500	3500	3500	3500	3500	3500	3500	3500	3500	3800	4500	3800	4500	4500	4500	
Max. input speed	n_{1Max}	rpm	7500	7500	7500	7500	7500	7500	7500	7500	7500	7500	7500	7500	7500	7500	7500	
Mean no load running torque ^{b)} (at $n_i = 3000$ rpm and 20 °C gearbox temperature)	T_{012}	Nm	0.56	0.48	0.47	0.44	0.40	0.40	0.40	0.28	0.32	0.32	0.23	0.32	0.24	0.24	0.25	
		in.lb	5.0	4.2	4.2	3.9	3.5	3.5	3.5	2.5	2.8	2.8	2.0	2.8	2.1	2.1	2.2	
Max. backlash	j_t	arcmin	Standard ≤ 3 / Reduced ≤ 1															
Torsional rigidity ^{b)}	C_{t21}	Nm/arcmin	32	32	26	32	31	24	31	32	30	30	24	30	28	21	22	
		in.lb/arcmin	283	283	230	283	274	212	274	283	266	266	212	266	248	186	195	
Tilting rigidity	C_{2K}	Nm/arcmin	225															
		in.lb/arcmin	1991															
Max. axial force ^{c)}	F_{2AMax}	N	2795															
		lb _f	629															
Max. tilting moment	M_{2KMax}	Nm	270															
		in.lb	2390															
Efficiency at full load	η	%	94															
Service life	L_h	h	> 20000															
Weight (incl. standard adapter plate)	m	kg	3.6															
		lb _m	8.0															
Operating noise (at reference ratio and reference speed – ratio-specific values available in cymex [®])	L_{PA}	dB(A)	≤ 55															
Max. permitted housing temperature		°C	+90															
		F	194															
Ambient temperature		°C	-15 to +40															
		F	5 to 104															
Lubrication			Lubricated for life															
Direction of rotation			In- and output same direction															
Protection class			IP 65															
Metal bellows coupling (recommended product type – validate sizing with cymex [®])			BCT-00060AAX-050.000															
Bore diameter of coupling on the application side		mm	X = 014.000 - 035.000															
Mass moment of inertia (relates to the drive) Clamping hub diameter [mm] Optimized mass inertia version available on request	B	11	J_i	kgcm ²	0.17	0.14	0.15	0.13	0.11	0.14	0.11	0.10	0.09	0.09	0.09	0.10	0.09	0.09
				10 ⁻³ in.lb.s ²	0.15	0.12	0.13	0.12	0.10	0.12	0.10	0.09	0.08	0.08	0.08	0.09	0.08	0.08
	C	14	J_i	kgcm ²	0.24	0.21	0.22	0.20	0.18	0.21	0.18	0.18	0.17	0.17	0.17	0.17	0.16	0.17
				10 ⁻³ in.lb.s ²	0.21	0.19	0.20	0.18	0.16	0.18	0.16	0.16	0.15	0.15	0.15	0.15	0.15	0.15
	E	19	J_i	kgcm ²	0.56	0.53	0.55	0.53	0.51	0.53	0.51	0.50	0.49	0.49	0.49	0.52	0.49	0.49
				10 ⁻³ in.lb.s ²	0.50	0.47	0.48	0.47	0.45	0.47	0.45	0.44	0.43	0.43	0.43	0.43	0.46	0.43

Please use our sizing software cymex[®] for a detailed sizing – www.wittenstein-cymex.com

^{a)} At max. 10 % M_{2KMax}

^{b)} Valid for standard clamping hub diameter

^{c)} Refers to center of the output shaft or flange

^{d)} Please reduce input speed at higher ambient temperatures

View A

View B

2-stage

up to 11⁴⁾ (B)
clamping hub
diameter

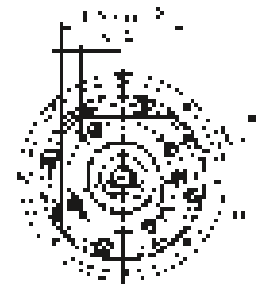
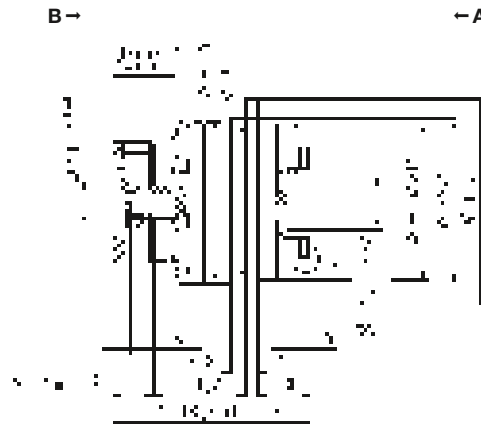
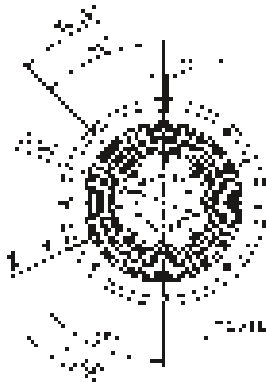

up to 14⁴⁾ (C)⁵⁾
clamping hub
diameter

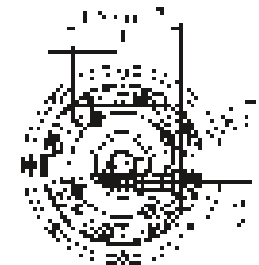

up to 19⁴⁾ (E)
clamping hub
diameter

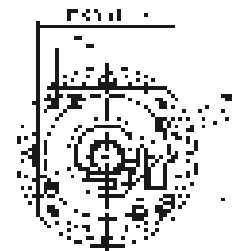
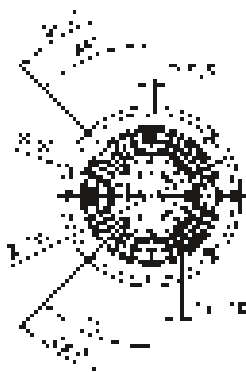

Motor shaft diameter [mm]

Planetary gearboxes

TP*

MF

Non-tolerated dimensions are nominal dimensions

¹⁾ Check motor shaft fit

²⁾ Min./Max. permissible motor shaft length. Longer motor shafts are possible, please contact alpha.

³⁾ The dimensions depend on the motor

⁴⁾ Smaller motor shaft diameter is compensated by a bushing with a minimum thickness of 1 mm

⁵⁾ Standard clamping hub diameter

TP+ 025 MF 1-stage

			1-stage						
Ratio	<i>i</i>		4	5	7	8	10		
Max. torque ^{a) b)}	T_{2a}	Nm	352	380	352	352	352		
		in.lb	3115	3363	3115	3115	3115		
Max. acceleration torque ^{b)} (max. 1000 cycles per hour)	T_{2B}	Nm	352	380	352	318	318		
		in.lb	3115	3363	3115	2815	2815		
Nominal torque (at n_n)	T_{2N}	Nm	175	169	172	172	180		
		in.lb	1548	1498	1524	1521	1591		
Emergency stop torque ^{a) b)} (permitted 1000 times during the service life of the gearbox)	T_{2Not}	Nm	625	625	625	625	625		
		in.lb	5532	5532	5532	5532	5532		
Permitted average input speed (at T_{2a} and 20 °C ambient temperature) ^{d)}	n_{1N}	rpm	2300	2500	2500	2500	2500		
Max. input speed	n_{1Max}	rpm	5500	5500	5500	5500	5500		
Mean no load running torque ^{b)} (at $n_i = 3000$ rpm and 20 °C gearbox temperature)	T_{012}	Nm	2.8	2.3	1.7	1.7	1.2		
		in.lb	25	20	15	15	10		
Max. backlash	j_t	arcmin	Standard ≤ 3 / Reduced ≤ 1						
Torsional rigidity ^{b)}	C_{t21}	Nm/arcmin	80	86	76	62	62		
		in.lb/arcmin	708	761	673	549	549		
Tilting rigidity	C_{2K}	Nm/arcmin	550						
		in.lb/arcmin	4868						
Max. axial force ^{c)}	F_{2AMax}	N	4800						
		lb _f	1080						
Max. tilting moment	M_{2KMax}	Nm	440						
		in.lb	3894						
Efficiency at full load	η	%	97						
Service life	L_h	h	> 20000						
Weight (incl. standard adapter plate)	m	kg	6.5						
		lb _m	14.4						
Operating noise (at reference ratio and reference speed – ratio-specific values available in cymex [®])	L_{PA}	dB(A)	≤ 61						
Max. permitted housing temperature		°C	+90						
		F	194						
Ambient temperature		°C	-15 to +40						
		F	5 to 104						
Lubrication			Lubricated for life						
Direction of rotation			In- and output same direction						
Protection class			IP 65						
Metal bellows coupling (recommended product type – validate sizing with cymex [®])			BCT-00150AAX-063.000						
Bore diameter of coupling on the application side		mm	X = 019.000 - 042.000						
Mass moment of inertia (relates to the drive) Clamping hub diameter [mm] Optimized mass inertia version available on request	E	19	J_1	kgcm ²	2.59	2.11	1.69	1.69	1.45
				10 ⁻³ in.lb.s ²	2.29	1.87	1.50	1.50	1.28
	G	24	J_1	kgcm ²	3.28	2.80	2.38	2.38	2.14
				10 ⁻³ in.lb.s ²	2.90	2.48	2.11	2.11	1.89
	H	28	J_1	kgcm ²	2.89	2.41	1.99	1.99	1.75
				10 ⁻³ in.lb.s ²	2.56	2.13	1.76	1.76	1.55
	K	38	J_1	kgcm ²	10.3	9.87	9.45	9.45	9.21
				10 ⁻³ in.lb.s ²	9.12	8.73	8.36	8.36	8.15

Please use our sizing software cymex[®] for a detailed sizing – www.wittenstein-cymex.com

^{a)} At max. 10 % M_{2KMax}

^{b)} Valid for standard clamping hub diameter

^{c)} Refers to center of the output shaft or flange

^{d)} Please reduce input speed at higher ambient temperatures

View A

View B

1-stage

up to 19⁴⁾ (E)
clamping hub diameter

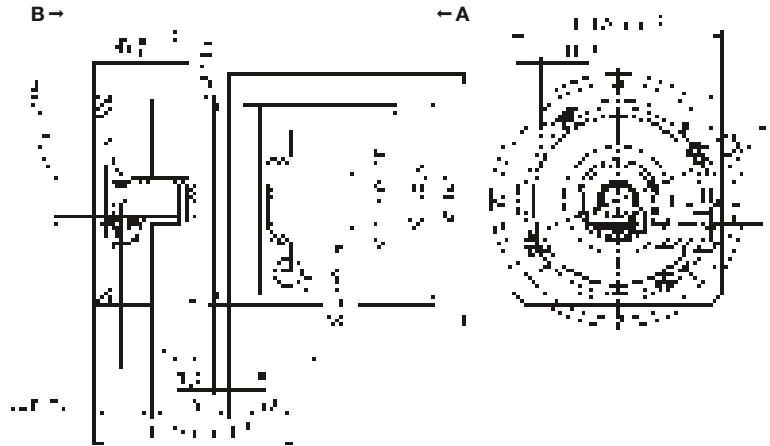
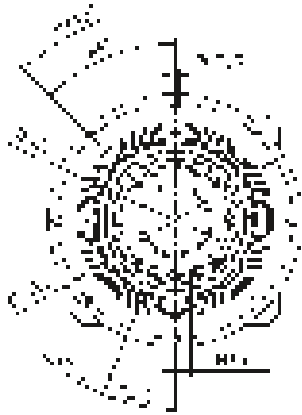

up to 24/28⁴⁾
(G⁵⁾/H) clamping hub diameter

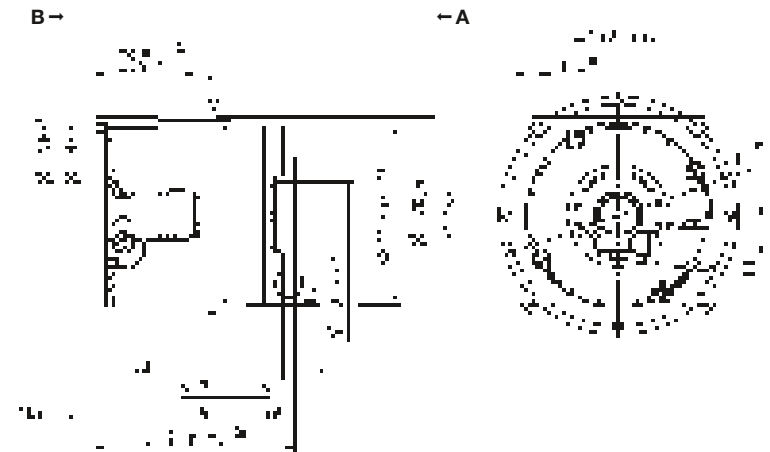
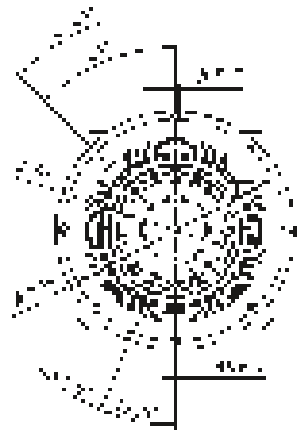

up to 38⁴⁾ (K)
clamping hub diameter

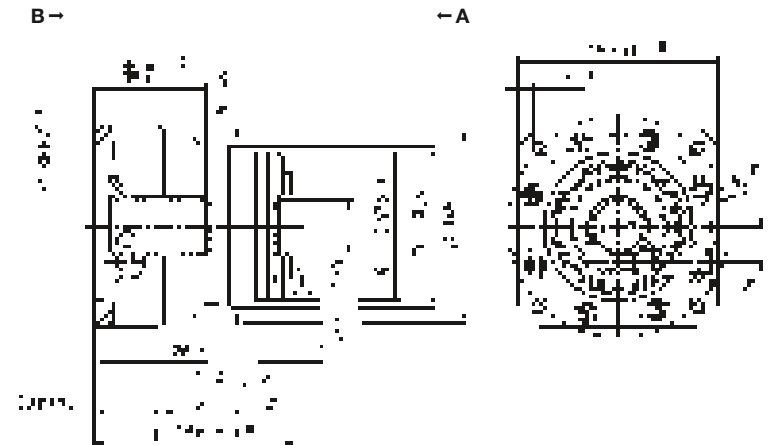
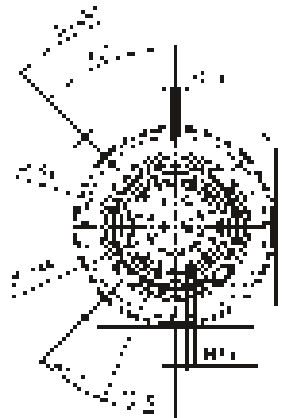

Motor shaft diameter [mm]

Planetary gearboxes

TP+
MF

Non-tolerated dimensions are nominal dimensions

¹⁾ Check motor shaft fit

²⁾ Min./Max. permissible motor shaft length. Longer motor shafts are possible, please contact alpha.

³⁾ The dimensions depend on the motor

⁴⁾ Smaller motor shaft diameter is compensated by a bushing with a minimum thickness of 1 mm

⁵⁾ Standard clamping hub diameter

TP+ 025 MF 2-stage

			2-stage																
Ratio	<i>i</i>		16	20	21	25	28	31	32	35	40	50	61	64	70	91	100		
Max. torque ^{a) b)}	T_{2a}	Nm	352	352	352	380	352	352	352	380	352	380	352	352	352	352	352	352	
		in.lb	3115	3115	3115	3363	3115	3115	3115	3363	3115	3363	3115	3363	3115	3115	3115	3115	3115
Max. acceleration torque ^{b)} (max. 1000 cycles per hour)	T_{2B}	Nm	352	352	330	380	352	330	352	380	352	380	308	292	352	275	292	292	
		in.lb	3115	3115	2921	3363	3115	2921	3115	3363	3115	3363	2726	2584	3115	2434	2584	2584	
Nominal torque (at n_n)	T_{2N}	Nm	250	267	211	265	282	231	251	294	282	304	246	233	282	220	233	233	
		in.lb	2213	2366	1872	2348	2492	2047	2220	2598	2492	2691	2181	2064	2492	1947	2064	2064	
Emergency stop torque ^{a) b)} (permitted 1000 times during the service life of the gearbox)	T_{2Not}	Nm	625	625	625	625	625	625	625	625	625	625	625	625	625	625	625	625	
		in.lb	5532	5532	5532	5532	5532	5532	5532	5532	5532	5532	5532	5532	5532	5532	5532	5532	
Permitted average input speed (at T_{2a} and 20 °C ambient temperature) ^{d)}	n_{1N}	rpm	2800	2800	2800	2800	2800	2800	2800	2800	2800	3100	3500	3100	3500	4200	4200		
Max. input speed	n_{1Max}	rpm	7500	7500	7500	7500	7500	7500	7500	7500	7500	7500	7500	7500	7500	7500	7500		
Mean no load running torque ^{b)} (at $n_i = 3000$ rpm and 20 °C gearbox temperature)	T_{012}	Nm	1.2	1.0	1.1	0.90	0.80	0.84	0.80	0.60	0.59	0.50	0.48	0.50	0.42	0.48	0.38		
		in.lb	10	8.9	9.9	8.0	7.1	7.4	7.1	5.3	5.2	4.4	4.2	4.4	3.7	4.2	3.4		
Max. backlash	j_t	arcmin	Standard ≤ 3 / Reduced ≤ 1																
Torsional rigidity ^{b)}	C_{t21}	Nm/arcmin	81	81	70	83	80	54	80	82	76	80	61	80	71	55	60		
		in.lb/arcmin	717	717	620	735	708	478	708	726	673	708	540	708	628	487	531		
Tilting rigidity	C_{2K}	Nm/arcmin	550																
		in.lb/arcmin	4868																
Max. axial force ^{c)}	F_{2AMax}	N	4800																
		lb _f	1080																
Max. tilting moment	M_{2KMax}	Nm	440																
		in.lb	3894																
Efficiency at full load	η	%	94																
Service life	L_h	h	> 20000																
Weight (incl. standard adapter plate)	m	kg	6.7																
		lb _m	14.8																
Operating noise (at reference ratio and reference speed – ratio-specific values available in cymex [®])	L_{PA}	dB(A)	≤ 58																
Max. permitted housing temperature		°C	+90																
		F	194																
Ambient temperature		°C	-15 to +40																
		F	5 to 104																
Lubrication			Lubricated for life																
Direction of rotation			In- and output same direction																
Protection class			IP 65																
Metal bellows coupling (recommended product type – validate sizing with cymex [®])			BCT-00150AAX-063.000																
Bore diameter of coupling on the application side		mm	X = 019.000 - 042.000																
Mass moment of inertia (relates to the drive) Clamping hub diameter [mm] Optimized mass inertia version available on request	C	14	J_1	kgcm ²	0.66	0.55	0.60	0.53	0.44	0.55	0.44	0.43	0.38	0.38	0.39	0.40	0.37	0.38	0.37
				10 ⁻³ in.lb.s ²	0.58	0.48	0.53	0.47	0.39	0.49	0.39	0.38	0.34	0.33	0.34	0.36	0.33	0.34	0.33
	E	19	J_1	kgcm ²	0.83	0.71	0.77	0.70	0.61	0.72	0.61	0.60	0.55	0.55	0.55	0.57	0.54	0.55	0.54
				10 ⁻³ in.lb.s ²	0.73	0.63	0.68	0.62	0.54	0.64	0.54	0.53	0.49	0.48	0.49	0.50	0.48	0.48	0.48
	G	24	J_1	kgcm ²	2.20	2.08	2.14	2.07	1.98	2.09	1.98	1.97	1.92	1.92	1.92	2.00	1.91	1.92	1.91
				10 ⁻³ in.lb.s ²	1.95	1.84	1.89	1.83	1.75	1.85	1.75	1.74	1.70	1.70	1.70	1.77	1.69	1.70	1.69
	H	28	J_1	kgcm ²	2.00	1.91	1.96	1.89	1.82	1.85	1.89	1.81	1.76	1.76	1.76	1.83	1.75	1.75	1.75
				10 ⁻³ in.lb.s ²	1.77	1.69	1.73	1.67	1.61	1.64	1.67	1.60	1.56	1.56	1.56	1.62	1.55	1.55	1.55

Please use our sizing software cymex[®] for a detailed sizing – www.wittenstein-cymex.com

^{a)} At max. 10 % M_{2KMax}

^{b)} Valid for standard clamping hub diameter

^{c)} Refers to center of the output shaft or flange

^{d)} Please reduce input speed at higher ambient temperatures

View A

View B

2-stage

up to 14⁴⁾ (C)
clamping hub diameter

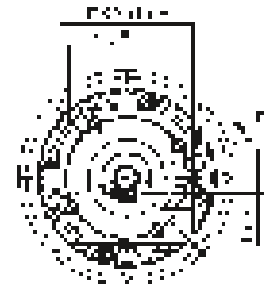
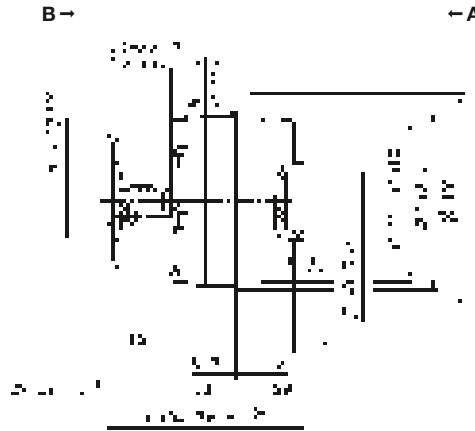
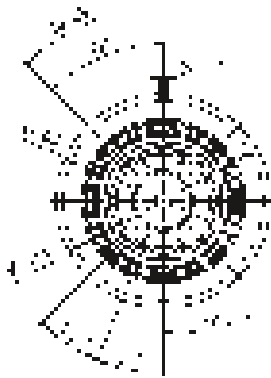

up to 19⁴⁾ (E)⁵⁾
clamping hub diameter

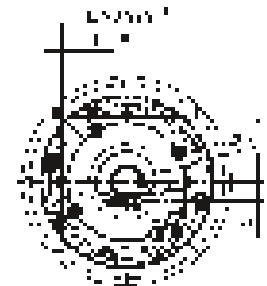
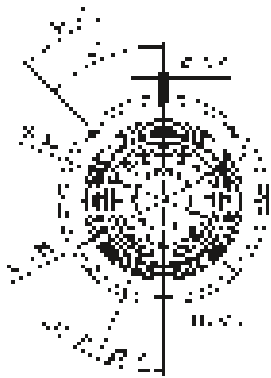

up to 24/28⁴⁾
(G/H) clamping
hub diameter

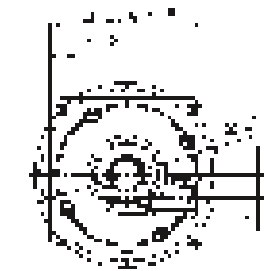
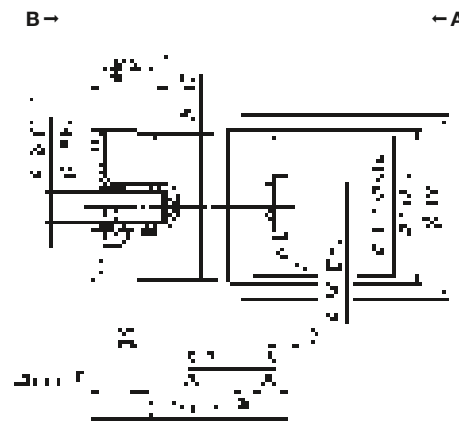
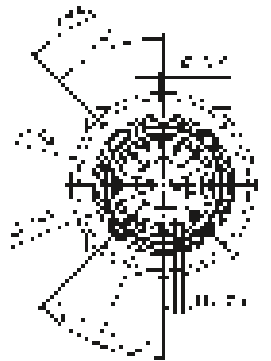

Motor shaft diameter [mm]

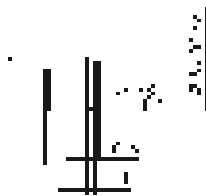

Planetary gearboxes

TP+
MF

Non-tolerated dimensions are nominal dimensions

¹⁾ Check motor shaft fit

²⁾ Min./Max. permissible motor shaft length. Longer motor shafts are possible, please contact alpha.

³⁾ The dimensions depend on the motor

⁴⁾ Smaller motor shaft diameter is compensated by a bushing with a minimum thickness of 1 mm

⁵⁾ Standard clamping hub diameter

TP+ 050 MF 1-stage

			1-stage						
Ratio	<i>i</i>		4	5	7	8	10		
Max. torque ^{a) b)}	T_{2a}	Nm	992	992	868	720	720		
		in.lb	8780	8780	7686	6373	6373		
Max. acceleration torque ^{b)} (max. 1000 cycles per hour)	T_{2B}	Nm	840	840	840	648	648		
		in.lb	7435	7435	7435	5735	5735		
Nominal torque (at n_N)	T_{2N}	Nm	345	337	322	316	331		
		in.lb	3052	2987	2854	2796	2928		
Emergency stop torque ^{a) b)} (permitted 1000 times during the service life of the gearbox)	T_{2Not}	Nm	1250	1250	1250	1250	1250		
		in.lb	11064	11064	11064	11064	11064		
Permitted average input speed (at T_{2a} and 20 °C ambient temperature) ^{d)}	n_{1N}	rpm	1900	2000	2500	2500	2500		
Max. input speed	n_{1Max}	rpm	5000	5000	5000	5000	5000		
Mean no load running torque ^{b)} (at $n_1 = 3000$ rpm and 20 °C gearbox temperature)	T_{012}	Nm	6.5	5.3	3.8	3.8	2.6		
		in.lb	57	47	33	33	23		
Max. backlash	j_t	arcmin	Standard ≤ 3 / Reduced ≤ 1						
Torsional rigidity ^{b)}	C_{t21}	Nm/arcmin	190	187	159	123	123		
		in.lb/arcmin	1682	1655	1407	1089	1089		
Tilting rigidity	C_{2K}	Nm/arcmin	560						
		in.lb/arcmin	4956						
Max. axial force ^{c)}	F_{2AMax}	N	6130						
		lb _f	1379						
Max. tilting moment	M_{2KMax}	Nm	1335						
		in.lb	11816						
Efficiency at full load	η	%	97						
Service life	L_h	h	> 20000						
Weight (incl. standard adapter plate)	m	kg	14						
		lb _m	30.9						
Operating noise (at reference ratio and reference speed – ratio-specific values available in cymex [®])	L_{PA}	dB(A)	≤ 64						
			+90						
Max. permitted housing temperature		°C	+90						
		F	194						
Ambient temperature		°C	-15 to +40						
		F	5 to 104						
Lubrication			Lubricated for life						
Direction of rotation			In- and output same direction						
Protection class			IP 65						
Metal bellows coupling (recommended product type – validate sizing with cymex [®])			BCT-00300AAX-080.000						
Bore diameter of coupling on the application side		mm	X = 024.000 - 060.000						
Mass moment of inertia (relates to the drive) Clamping hub diameter [mm] Optimized mass inertia version available on request	G	24	J_1	kgcm ²	9.47	7.85	6.39	6.39	5.54
				10 ⁻³ in.lb.s ²	8.38	6.95	5.66	5.66	4.90
	I	32	J_1	kgcm ²	12.6	11.0	9.55	9.55	8.10
				10 ⁻³ in.lb.s ²	11.2	9.74	8.45	8.45	7.17
	K	38	J_1	kgcm ²	13.7	12.1	10.6	10.6	9.78
				10 ⁻³ in.lb.s ²	12.1	10.7	9.38	9.38	8.66
	M	48	J_1	kgcm ²	28.3	26.7	25.3	25.3	24.4
				10 ⁻³ in.lb.s ²	25.1	23.6	22.4	22.4	21.6

Please use our sizing software cymex[®] for a detailed sizing – www.wittenstein-cymex.com

^{a)} At max. 10 % M_{2KMax}

^{b)} Valid for standard clamping hub diameter

^{c)} Refers to center of the output shaft or flange

^{d)} Please reduce input speed at higher ambient temperatures

View A

View B

1-stage

up to 24⁴⁾ (G)
clamping hub diameter

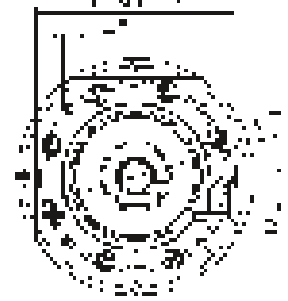
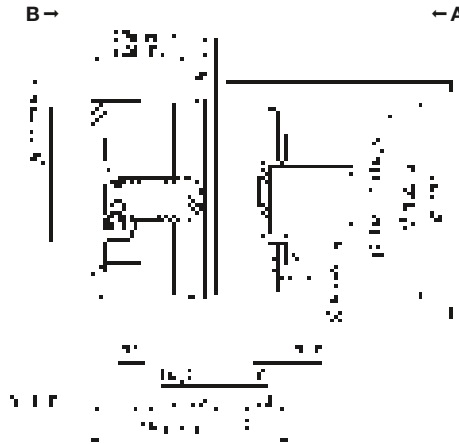
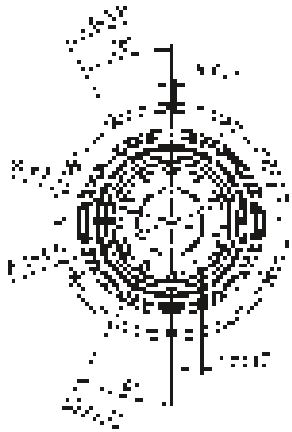

up to 32/38⁴⁾
(I/K⁵⁾) clamping hub diameter

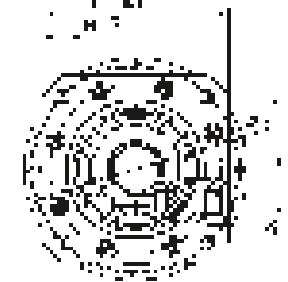
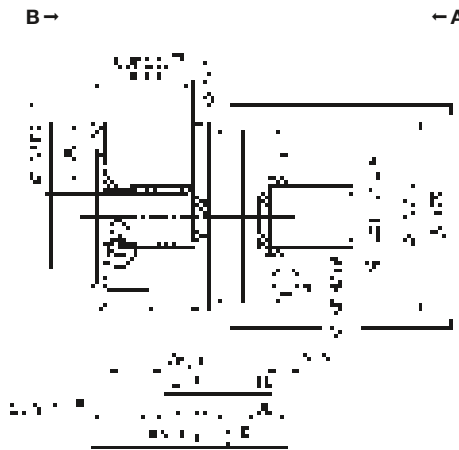
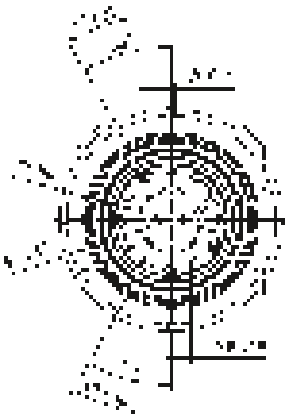

up to 48⁴⁾ (M)
clamping hub diameter

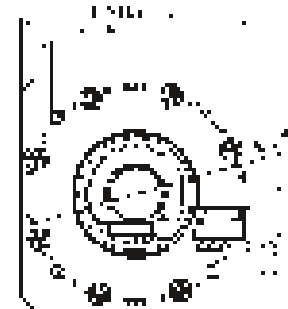
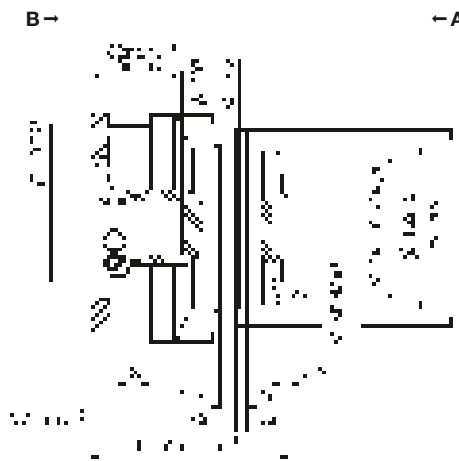
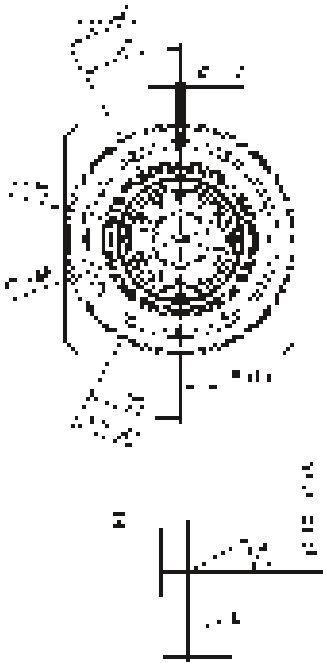

Motor shaft diameter [mm]

Planetary gearboxes

TP+

MF

Non-tolerated dimensions are nominal dimensions

¹⁾ Check motor shaft fit

²⁾ Min./Max. permissible motor shaft length. Longer motor shafts are possible, please contact alpha.

³⁾ The dimensions depend on the motor

⁴⁾ Smaller motor shaft diameter is compensated by a bushing with a minimum thickness of 1 mm

⁵⁾ Standard clamping hub diameter

TP+ 050 MF 2-stage

			2-stage																
Ratio	<i>i</i>		16	20	21	25	28	31	32	35	40	50	61	64	70	91	100		
Max. torque ^{a) b)}	T_{2a}	Nm	825	825	660	825	825	682	825	825	825	825	605	594	770	550	594		
		in.lb	7302	7302	5842	7302	7302	6036	7302	7302	7302	7302	7302	5355	5257	6815	4868	5257	
Max. acceleration torque ^{b)} (max. 1000 cycles per hour)	T_{2B}	Nm	825	825	660	825	825	682	825	825	825	825	605	594	770	550	594		
		in.lb	7302	7302	5842	7302	7302	6036	7302	7302	7302	7302	7302	5355	5257	6815	4868	5257	
Nominal torque (at n_n)	T_{2N}	Nm	461	493	393	489	545	431	464	541	607	585	425	475	598	440	475		
		in.lb	4078	4361	3476	4332	4824	3812	4104	4792	5370	5179	3765	4206	5291	3894	4206		
Emergency stop torque ^{a) b)} (permitted 1000 times during the service life of the gearbox)	T_{2Not}	Nm	1250	1250	1250	1250	1250	1250	1250	1250	1250	1250	1250	1250	1250	1250	1250		
		in.lb	11064	11064	11064	11064	11064	11064	11064	11064	11064	11064	11064	11064	11064	11064	11064		
Permitted average input speed (at T_{2a} and 20 °C ambient temperature) ^{d)}	n_{1N}	rpm	2900	2900	2900	2900	2900	2900	2900	2900	2900	3200	3200	3200	3200	3900	3900		
Max. input speed	n_{1Max}	rpm	6250	6250	6250	6250	6250	6250	6250	6250	6250	6250	6250	6250	6250	6250	6250		
Mean no load running torque ^{b)} (at $n_i = 3000$ rpm and 20 °C gearbox temperature)	T_{012}	Nm	2.8	2.4	2.2	2.6	2.0	1.9	2.0	1.5	1.5	1.2	1.0	1.2	1.1	0.96	0.88		
		in.lb	25	22	20	23	17	17	17	14	13	11	8.9	11	9.9	8.5	7.8		
Max. backlash	j_t	arcmin	Standard ≤ 3 / Reduced ≤ 1																
Torsional rigidity ^{b)}	C_{t21}	Nm/arcmin	180	185	145	180	180	130	180	175	175	175	123	175	145	100	115		
		in.lb/arcmin	1593	1637	1283	1593	1593	1151	1593	1549	1549	1549	1089	1549	1283	885	1018		
Tilting rigidity	C_{2K}	Nm/arcmin	560																
		in.lb/arcmin	4956																
Max. axial force ^{c)}	F_{2AMax}	N	6130																
		lb _f	1379																
Max. tilting moment	M_{2KMax}	Nm	1379																
		in.lb	11816																
Efficiency at full load	η	%	94																
Service life	L_h	h	> 20000																
Weight (incl. standard adapter plate)	m	kg	14.1																
		lb _m	31.2																
Operating noise (at reference ratio and reference speed – ratio-specific values available in cymex [®])	L_{PA}	dB(A)	≤ 58																
		°C	+90																
Max. permitted housing temperature	F	°C	-15 to +40																
		F	5 to 104																
Ambient temperature			-15 to +40																
Lubrication			Lubricated for life																
			Lubricated for life																
Direction of rotation			In- and output same direction																
Protection class			IP 65																
Metal bellows coupling (recommended product type – validate sizing with cymex [®])			BCT-00300AAX-080.000																
Bore diameter of coupling on the application side		mm	X = 024.000 - 060.000																
Mass moment of inertia (relates to the drive) Clamping hub diameter [mm] Optimized mass inertia version available on request	E	19	J_i	kgcm ²	2.53	2.08	2.30	2.01	1.67	2.12	1.67	1.64	1.44	1.42	1.46	1.51	1.41	1.43	1.40
				10 ⁻³ in.lb.s ²	2.24	1.84	2.04	1.78	1.48	1.88	1.48	1.45	1.27	1.26	1.29	1.34	1.25	1.27	1.24
	G	24	J_i	kgcm ²	3.22	2.77	2.99	2.70	2.37	2.81	2.37	2.33	2.13	2.12	2.15	2.20	2.10	2.12	2.09
				10 ⁻³ in.lb.s ²	2.85	2.45	2.65	2.39	2.10	2.49	2.10	2.06	1.89	1.88	1.90	1.95	1.86	1.88	1.85
	K	38	J_i	kgcm ²	10.3	9.83	10.1	9.77	9.43	9.88	9.43	9.40	9.20	9.18	9.22	9.50	9.17	9.19	9.16
				10 ⁻³ in.lb.s ²	9.12	8.70	8.94	8.65	8.35	8.74	8.35	8.32	8.14	8.12	8.16	8.41	8.12	8.13	8.11

Please use our sizing software cymex[®] for a detailed sizing – www.wittenstein-cymex.com

^{a)} At max. 10 % M_{2KMax}

^{b)} Valid for standard clamping hub diameter

^{c)} Refers to center of the output shaft or flange

^{d)} Please reduce input speed at higher ambient temperatures

View A

View B

2-stage

up to 19⁴⁾ (E)
clamping hub
diameter

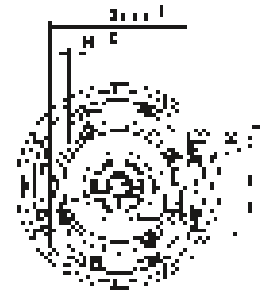
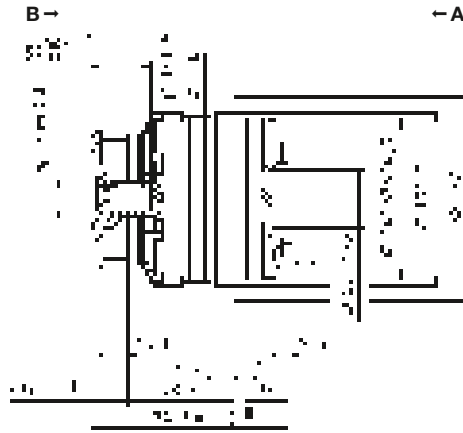
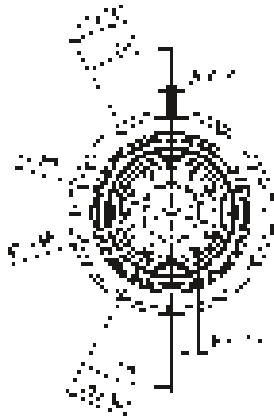

up to 24⁴⁾ (G)⁵⁾
clamping hub
diameter

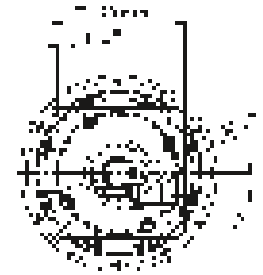
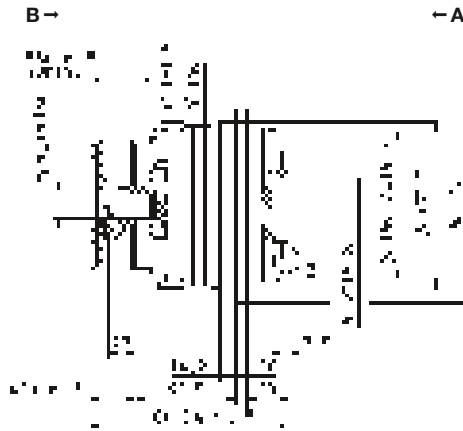
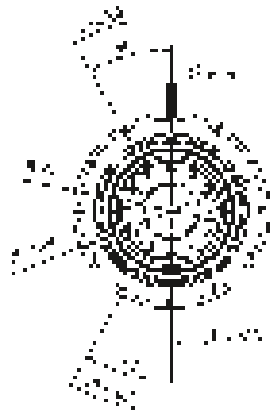

up to 38⁴⁾ (K)
clamping hub
diameter

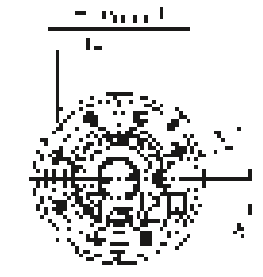
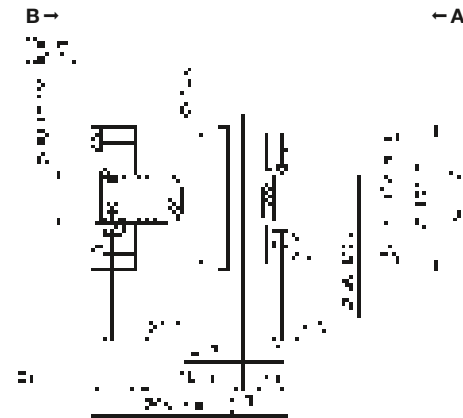
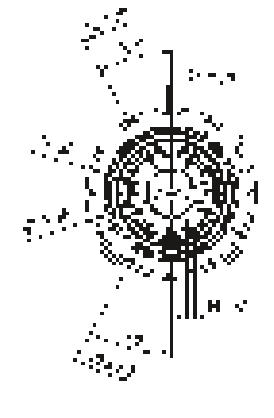

Motor shaft diameter [mm]

Planetary gearboxes

TP+
MF

Non-tolerated dimensions are nominal dimensions

¹⁾ Check motor shaft fit

²⁾ Min./Max. permissible motor shaft length. Longer motor shafts are possible, please contact alpha.

³⁾ The dimensions depend on the motor

⁴⁾ Smaller motor shaft diameter is compensated by a bushing with a minimum thickness of 1 mm

⁵⁾ Standard clamping hub diameter

TP+ 110 MF 1-stage

			1-stage						
Ratio	<i>i</i>		4	5	7	8	10		
Max. torque ^{a) b)}	T_{2a}	Nm	2560	2560	2560	2240	2240		
		in.lb	22658	22658	22658	19826	19826		
Max. acceleration torque ^{b)} (max. 1000 cycles per hour)	T_{2B}	Nm	1920	1920	1920	1680	1680		
		in.lb	16994	16994	16994	14869	14869		
Nominal torque (at n_n)	T_{2N}	Nm	946	919	861	861	901		
		in.lb	8375	8134	7618	7618	7972		
Emergency stop torque ^{a) b)} (permitted 1000 times during the service life of the gearbox)	T_{2Not}	Nm	3075	3075	3075	3075	3075		
		in.lb	27216	27216	27216	27216	27216		
Permitted average input speed (at T_{2a} and 20 °C ambient temperature) ^{d)}	n_{1N}	rpm	1400	1500	2000	2000	2000		
Max. input speed	n_{1Max}	rpm	4500	4500	4500	4500	4500		
Mean no load running torque ^{b)} (at $n_i = 3000$ rpm and 20 °C gearbox temperature)	T_{012}	Nm	16	12	8.8	8.8	6.0		
		in.lb	138	109	78	78	53		
Max. backlash	j_t	arcmin	Standard ≤ 3 / Reduced ≤ 1						
Torsional rigidity ^{b)}	C_{t21}	Nm/arcmin	610	610	550	445	445		
		in.lb/arcmin	5399	5399	4868	3939	3939		
Tilting rigidity	C_{2K}	Nm/arcmin	1452						
		in.lb/arcmin	12851						
Max. axial force ^{c)}	F_{2AMax}	N	10050						
		lb _f	2261						
Max. tilting moment	M_{2KMax}	Nm	3280						
		in.lb	29031						
Efficiency at full load	η	%	97						
Service life	L_h	h	> 20000						
Weight (incl. standard adapter plate)	m	kg	30						
		lb _m	66.3						
Operating noise (at reference ratio and reference speed – ratio-specific values available in cymex [®])	L_{PA}	dB(A)	≤ 68						
		°C	+90						
Max. permitted housing temperature	F	°C	+90						
		F	194						
Ambient temperature	F	°C	-15 to +40						
		F	5 to 104						
Lubrication			Lubricated for life						
Direction of rotation			In- and output same direction						
Protection class			IP 65						
Metal bellows coupling (recommended product type – validate sizing with cymex [®])			BCT-01500AAX-125.000						
Bore diameter of coupling on the application side		mm	X = 050.000 - 080.000						
Mass moment of inertia (relates to the drive) Clamping hub diameter [mm] Optimized mass inertia version available on request	K	38	J_1	kgcm ²	44.5	34.6	25.5	25.5	20.6
				10 ⁻³ in.lb.s ²	39.4	30.6	22.6	22.6	18.2
	M	48	J_1	kgcm ²	58.8	41.9	32.9	32.9	28.0
				10 ⁻³ in.lb.s ²	52.0	37.1	29.1	29.1	24.8
	N	55	J_1	kgcm ²	61.5	51.5	42.3	42.3	37.3
				10 ⁻³ in.lb.s ²	54.4	45.6	37.4	37.4	33.0

Please use our sizing software cymex[®] for a detailed sizing – www.wittenstein-cymex.com

^{a)} At max. 10 % M_{2KMax}

^{b)} Valid for standard clamping hub diameter

^{c)} Refers to center of the output shaft or flange

^{d)} Please reduce input speed at higher ambient temperatures

View A

View B

1-stage

up to 38⁴⁾ (K)
clamping hub
diameter

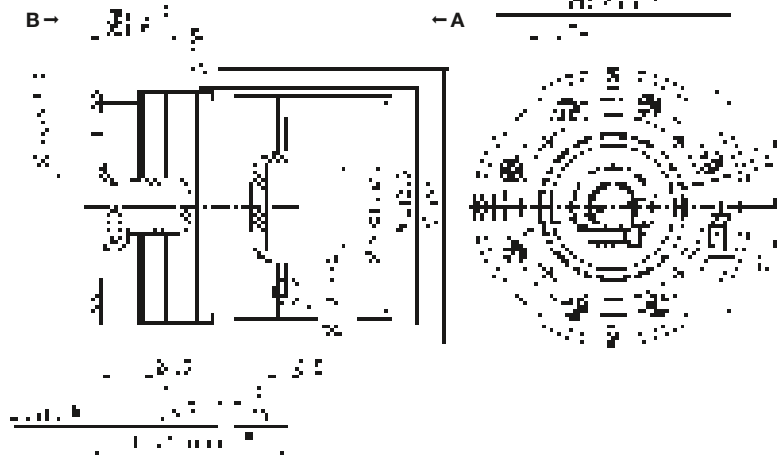
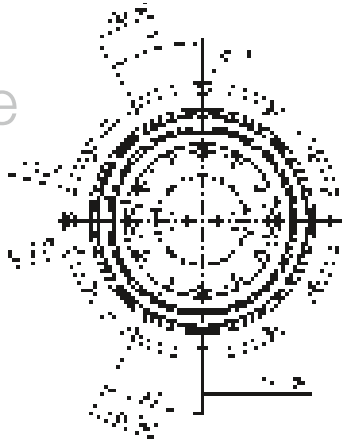

up to 48⁴⁾ (M)⁵⁾
clamping hub
diameter

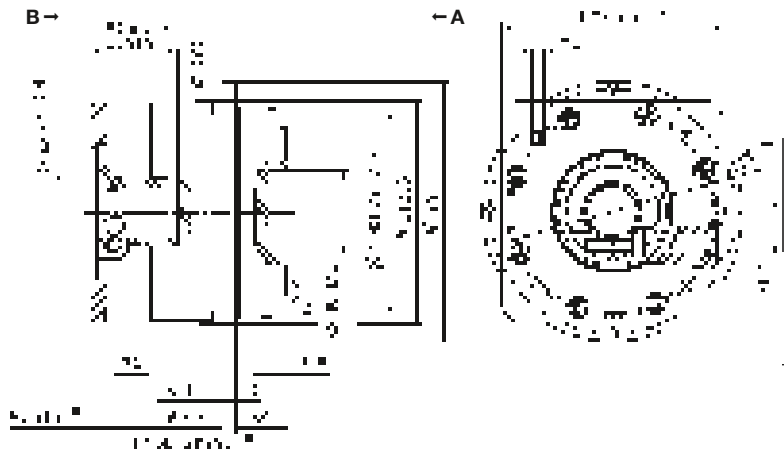
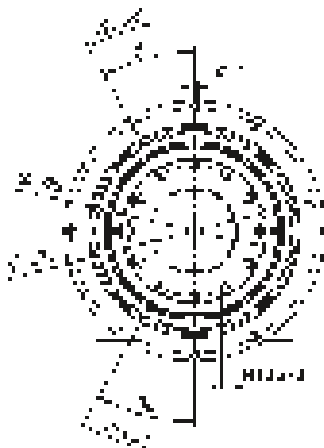

up to 55⁴⁾ (N)
clamping hub
diameter

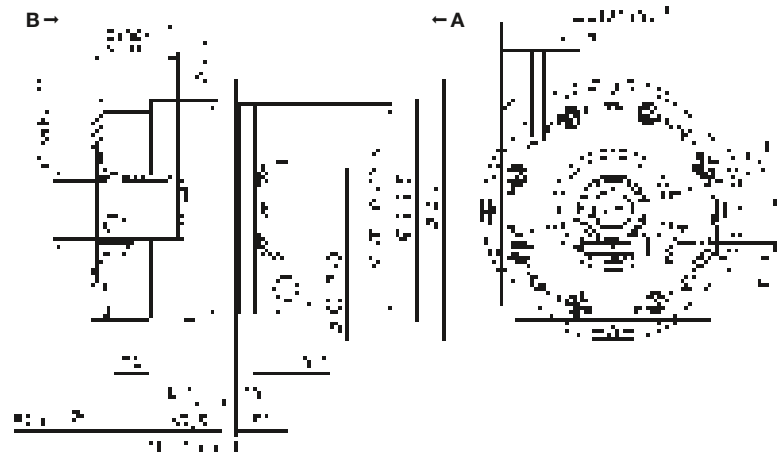
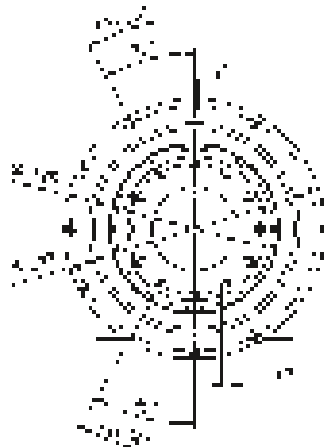

Motor shaft diameter [mm]

Planetary gearboxes

TP+
MF

Non-tolerated dimensions are nominal dimensions

¹⁾ Check motor shaft fit

²⁾ Min./Max. permissible motor shaft length. Longer motor shafts are possible, please contact alpha.

³⁾ The dimensions depend on the motor

⁴⁾ Smaller motor shaft diameter is compensated by a bushing with a minimum thickness of 1 mm

⁵⁾ Standard clamping hub diameter

TP+ 110 MF 2-stage

				2-stage															
Ratio	<i>i</i>			16	20	21	25	28	31	32	35	40	50	61	64	70	91	100	
Max. torque ^{a) b)}	T_{2a}	Nm		1760	1760	1540	1760	1760	1760	1760	1760	1760	1760	1540	1540	1760	1430	1540	
		in.lb		15577	15577	13630	15577	15577	15577	15577	15577	15577	15577	15577	13630	13630	15577	12657	13630
Max. acceleration torque ^{b)} (max. 1000 cycles per hour)	T_{2B}	Nm		1760	1760	1540	1760	1760	1760	1760	1760	1760	1760	1540	1540	1760	1430	1540	
		in.lb		15577	15577	13630	15577	15577	15577	15577	15577	15577	15577	15577	13630	13630	15577	12657	13630
Nominal torque (at n_n)	T_{2N}	Nm		1205	1240	1023	1278	1257	1065	1221	1408	1315	1408	1232	1232	1408	1144	1232	
		in.lb		10669	10976	9051	11312	11121	9422	10807	12462	11636	12462	10904	10904	12462	10125	10904	
Emergency stop torque ^{a) b)} (permitted 1000 times during the service life of the gearbox)	T_{2Not}	Nm		3075	3075	3075	3075	3075	3075	3075	3075	3075	3075	3075	3075	3075	3075	3075	
		in.lb		27216	27216	27216	27216	27216	27216	27216	27216	27216	27216	27216	27216	27216	27216	27216	27216
Permitted average input speed (at T_{2a} and 20 °C ambient temperature) ^{d)}	n_{1N}	rpm		2500	2500	2500	2500	2500	2500	2500	2500	2500	2900	3200	2900	3200	3400	3400	
Max. input speed	n_{1Max}	rpm		5625	5625	5625	5625	5625	5625	5625	5625	5625	5625	5625	5625	5625	5625	5625	
Mean no load running torque ^{b)} (at $n_i = 3000$ rpm and 20 °C gearbox temperature)	T_{012}	Nm		7.0	5.8	5.2	5.2	4.5	4.4	4.5	3.1	3.0	2.5	2.1	2.5	2.0	1.8	1.8	
		in.lb		52	52	46	46	40	39	40	28	27	22	18	22	18	16	16	
Max. backlash	j_t	arcmin		Standard ≤ 3 / Reduced ≤ 1															
Torsional rigidity ^{b)}	C_{t21}	Nm/arcmin		585	580	465	570	560	440	560	560	520	525	415	525	480	360	395	
		in.lb/arcmin		5178	5133	4116	5045	4956	3894	4956	4956	4602	4647	3673	4647	4248	3186	3496	
Tilting rigidity	C_{2K}	Nm/arcmin		1452															
		in.lb/arcmin		12851															
Max. axial force ^{c)}	F_{2AMax}	N		10050															
		lb _f		2261															
Max. tilting moment	M_{2KMax}	Nm		3280															
		in.lb		29031															
Efficiency at full load	η	%		94															
Service life	L_h	h		> 20000															
Weight (incl. standard adapter plate)	m	kg		34															
		lb _m		75.1															
Operating noise (at reference ratio and reference speed – ratio-specific values available in cymex [®])	L_{PA}	dB(A)		≤ 61															
Max. permitted housing temperature		°C		+90															
		F		194															
Ambient temperature		°C		-15 to +40															
		F		5 to 104															
Lubrication				Lubricated for life															
Direction of rotation				In- and output same direction															
Protection class				IP 65															
Metal bellows coupling (recommended product type – validate sizing with cymex [®])				BCT-01500AAX-125.000															
Bore diameter of coupling on the application side		mm		X = 050.000 - 080.000															
Mass moment of inertia (relates to the drive) Clamping hub diameter [mm] Optimized mass inertia version available on request	G	24	J_1	kgcm ²	8.51	8.21	8.98	7.82	6.57	8.09	6.57	6.37	5.63	5.54	5.63	5.78	5.44	5.51	5.40
				10 ⁻³ in.lb.s ²	7.53	7.27	7.95	6.92	5.81	7.16	5.81	5.64	4.98	4.90	4.98	5.12	4.81	4.88	4.78
	I	32	J_1	kgcm ²	11.7	11.4	12.1	11.0	9.73	11.3	9.73	9.54	8.80	8.70	8.80	8.95	8.61	8.67	8.56
				10 ⁻³ in.lb.s ²	10.4	10.1	10.7	9.74	8.61	10.0	8.61	8.44	7.79	7.70	7.79	7.92	7.62	7.67	7.58
	K	38	J_1	kgcm ²	12.7	12.5	13.2	12.1	10.8	12.3	10.8	10.6	9.87	9.77	9.87	10.0	9.68	9.74	9.63
				10 ⁻³ in.lb.s ²	11.2	11.1	11.7	10.7	9.56	10.9	9.56	9.39	8.73	8.65	8.73	8.87	8.57	8.62	8.52
	M	48	J_1	kgcm ²	27.4	27.1	27.8	26.7	25.4	26.9	25.4	25.3	24.5	24.4	24.5	24.9	24.3	24.4	24.3
				10 ⁻³ in.lb.s ²	24.3	24.0	24.6	23.6	22.5	23.8	22.5	22.4	21.7	21.6	21.7	22.0	21.5	21.6	21.5

Please use our sizing software cymex[®] for a detailed sizing – www.wittenstein-cymex.com

^{a)} At max. 10 % M_{2KMax}

^{b)} Valid for standard clamping hub diameter

^{c)} Refers to center of the output shaft or flange

^{d)} Please reduce input speed at higher ambient temperatures

View A

View B

2-stage

up to 24⁴⁾ (G)
clamping hub diameter

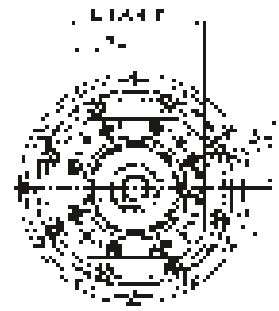
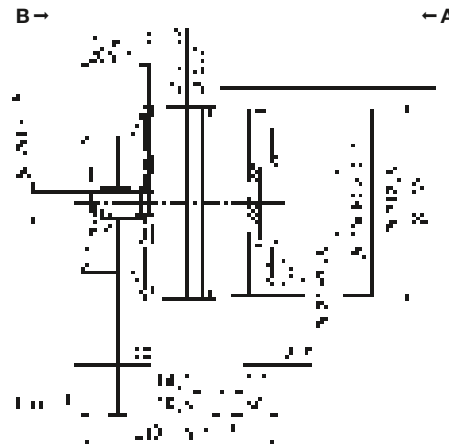
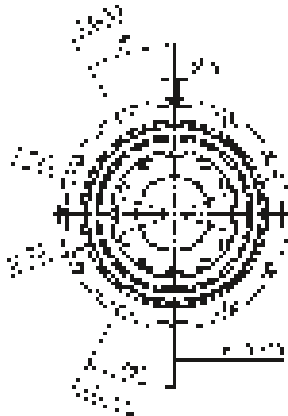

up to 32/38⁴⁾
(I/K⁵⁾) clamping hub diameter

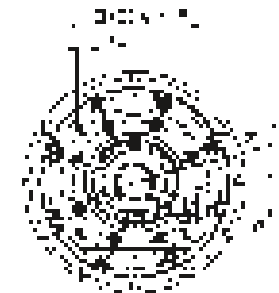
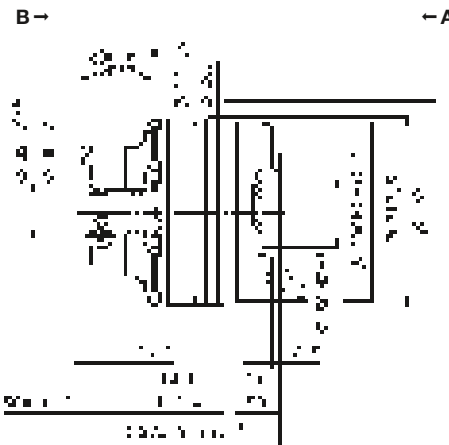
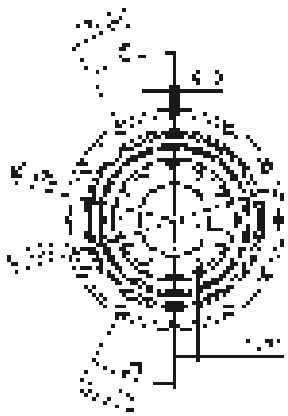

up to 48⁴⁾ (M)
clamping hub diameter

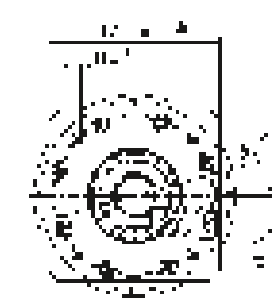
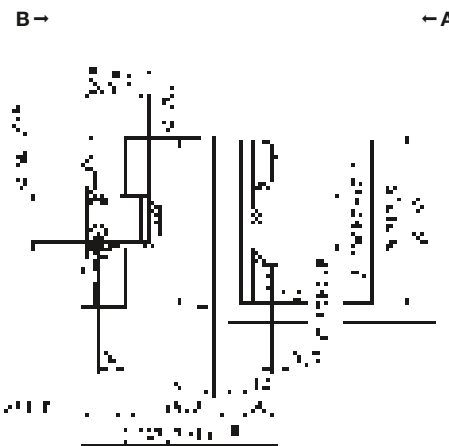
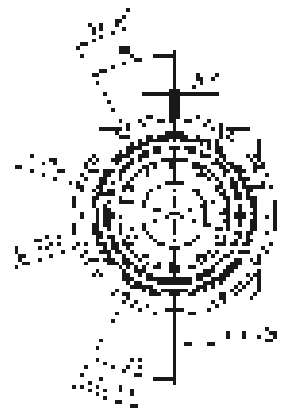

Motor shaft diameter [mm]



Planetary gearboxes

TP+

MF

Non-tolerated dimensions are nominal dimensions

¹⁾ Check motor shaft fit

²⁾ Min./Max. permissible motor shaft length. Longer motor shafts are possible, please contact alpha.

³⁾ The dimensions depend on the motor

⁴⁾ Smaller motor shaft diameter is compensated by a bushing with a minimum thickness of 1 mm

⁵⁾ Standard clamping hub diameter

TP+ 300 MF 1-stage

			1-stage					
Ratio	<i>i</i>		5	7	8	10		
Max. torque ^{a) b)}	T_{2a}	Nm	5600	5250	2800	2800		
		in.lb	49564	46467	24782	24782		
Max. acceleration torque ^{b)} (max. 1000 cycles per hour)	T_{2B}	Nm	4200	3960	2280	2280		
		in.lb	37173	35049	20180	20180		
Nominal torque (at n_n)	T_{2N}	Nm	1996	1835	1815	1794		
		in.lb	17666	16242	16063	15878		
Emergency stop torque ^{a) b)} (permitted 1000 times during the service life of the gearbox)	T_{2Not}	Nm	9900	9900	8557	8750		
		in.lb	87623	87623	75733	77445		
Permitted average input speed (at T_{2a} and 20 °C ambient temperature) ^{d)}	n_{1N}	rpm	1000	1400	1400	1700		
Max. input speed	n_{1Max}	rpm	3000	3000	3000	3000		
Mean no load running torque ^{b)} (at $n_1 = 2000$ rpm and 20 °C gearbox temperature)	T_{012}	Nm	20	14	14	8.8		
		in.lb	177	120	120	78		
Max. backlash	j_t	arcmin	Standard ≤ 3 / Reduced ≤ 1					
Torsional rigidity ^{b)}	C_{t21}	Nm/arcmin	1000	900	700	700		
		in.lb/arcmin	8851	7966	6196	6196		
Tilting rigidity	C_{2K}	Nm/arcmin	5560					
		in.lb/arcmin	49210					
Max. axial force ^{c)}	F_{2AMax}	N	33000					
		lb _f	7425					
Max. tilting moment	M_{2KMax}	Nm	3900					
		in.lb	34518					
Efficiency at full load	η	%	95					
Service life	L_h	h	> 20000					
Weight (incl. standard adapter plate)	m	kg	60					
		lb _m	132.6					
Operating noise (at reference ratio and reference speed – ratio-specific values available in cymex [®])	L_{PA}	dB(A)	≤ 64					
Max. permitted housing temperature		°C	+90					
		F	194					
Ambient temperature		°C	-15 to +40					
		F	5 to 104					
Lubrication			Lubricated for life					
Direction of rotation			In- and output same direction					
Protection class			IP 65					
Metal bellows coupling (recommended product type – validate sizing with cymex [®])			-					
Bore diameter of coupling on the application side		mm	-					
Mass moment of inertia (relates to the drive) Clamping hub diameter [mm] Optimized mass inertia version available on request	N	55	J_1	kgcm ²	82.6	61.2	61.2	49.5
				10 ⁻³ in.lb.s ²	73.1	54.2	54.2	43.8

Please use our sizing software cymex[®] for a detailed sizing – www.wittenstein-cymex.com

- ^{a)} At max. 10 % M_{2KMax}
- ^{b)} Valid for standard clamping hub diameter
- ^{c)} Refers to center of the output shaft or flange
- ^{d)} Please reduce input speed at higher ambient temperatures

View A

View B

Motor shaft diameter [mm]

1-stage

up to 55⁴⁾ (N)⁵⁾
clamping hub diameter

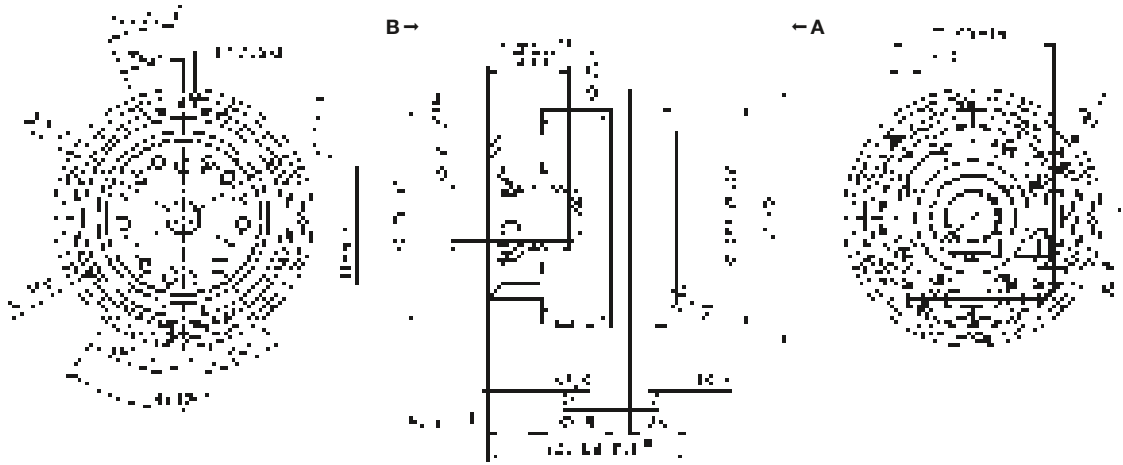

Planetary gearboxes

TP+

MF

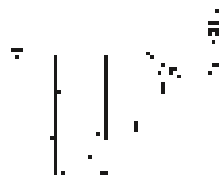

Non-tolerated dimensions are nominal dimensions

¹⁾ Check motor shaft fit

²⁾ Min./Max. permissible motor shaft length. Longer motor shafts are possible, please contact alpha.

³⁾ The dimensions depend on the motor

⁴⁾ Smaller motor shaft diameter is compensated by a bushing with a minimum thickness of 1 mm

⁵⁾ Standard clamping hub diameter

TP+ 300 MF 2-stage

				2-stage												
Ratio	i			20	21	25	31	32	35	50	61	64	70	91	100	
Max. torque ^{a) b)}	T_{2a}	Nm		3850	3740	3949	3850	3630	3949	3600	3080	2800	3630	2800	2800	
		in.lb		34076	33102	34947	34076	32128	34947	31863	27260	24782	32128	24782	24782	
Max. acceleration torque ^{b)} (max. 1000 cycles per hour)	T_{2B}	Nm		3850	3740	3949	3850	3630	3949	3600	3080	2800	3630	2800	2800	
		in.lb		34076	33102	34952	34076	32128	34952	31863	27260	24782	32128	24782	24782	
Nominal torque (at n_n)	T_{2N}	Nm		1354	1456	1676	2114	2353	1710	1722	2070	2240	2339	2240	2240	
		in.lb		11981	12888	14834	18709	20823	15131	15238	18320	19826	20698	19826	19826	
Emergency stop torque ^{a) b)} (permitted 1000 times during the service life of the gearbox)	T_{2Not}	Nm		9900	9870	9900	9156	9900	9900	9900	9008	9900	9900	8750	8750	
		in.lb		87623	87357	87623	81035	87623	87623	87623	79728	87623	87623	77445	77445	
Permitted average input speed (at T_{2a} and 20 °C ambient temperature) ^{d)}	n_{1N}	rpm		2000	2000	2000	2000	2000	2000	2300	2400	2300	2400	2500	2500	
Max. input speed	n_{1Max}	rpm		4375	4375	4375	4375	4375	4375	4375	4375	4375	4375	4375	4375	
Mean no load running torque ^{b)} (at $n_1 = 2000$ rpm and 20 °C gearbox temperature)	T_{012}	Nm		6.7	5.5	5.5	4.8	5.5	4.0	3.8	2.8	3.8	3.0	2.8	2.4	
		in.lb		59	49	48	43	48	35	34	25	34	26	25	21	
Max. backlash	j_t	arcmin		Standard ≤ 3 / Reduced ≤ 2												
Torsional rigidity ^{b)}	C_{t21}	Nm/arcmin		850	800	950	750	950	900	800	700	800	800	600	650	
		in.lb/arcmin		7523	7081	8408	6638	8408	7966	7081	6196	7081	7081	5310	5753	
Tilting rigidity	C_{2K}	Nm/arcmin		5560												
		in.lb/arcmin		49210												
Max. axial force ^{c)}	F_{2AMax}	N		33000												
		lb _f		7425												
Max. tilting moment	M_{2KMax}	Nm		5900												
		in.lb		52220												
Efficiency at full load	η	%		94												
Service life	L_h	h		> 20000												
Weight (incl. standard adapter plate)	m	kg		58.5												
		lb _m		129.3												
Operating noise (at reference ratio and reference speed – ratio-specific values available in cymex [®])	L_{PA}	dB(A)		≤ 61												
		°C		+90												
Max. permitted housing temperature		F		194												
		°C		-15 to +40												
Ambient temperature		F		5 to 104												
		°C														
Lubrication				Lubricated for life												
Direction of rotation				In- and output same direction												
Protection class				IP 65												
Metal bellows coupling (recommended product type – validate sizing with cymex [®])				-												
Bore diameter of coupling on the application side		mm		-												
Mass moment of inertia (relates to the drive) Clamping hub diameter [mm] Optimized mass inertia version available on request	M	48	J_1	kgcm ²	27.5	27.0	25.9	25.6	22.4	22.4	21.5	21.4	25.8	21.3	21.2	21.2
				10 ⁻³ in.lb.s ²	24.3	23.9	22.9	22.7	19.8	19.8	19.0	18.9	22.8	18.9	18.8	18.8

Please use our sizing software cymex[®] for a detailed sizing – www.wittenstein-cymex.com

^{a)} At max. 10 % M_{2KMax}

^{b)} Valid for standard clamping hub diameter

^{c)} Refers to center of the output shaft or flange

^{d)} Please reduce input speed at higher ambient temperatures

View A

View B

Motor shaft diameter [mm]

2-stage

up to 48⁴⁾ (M)⁵⁾
clamping hub diameter

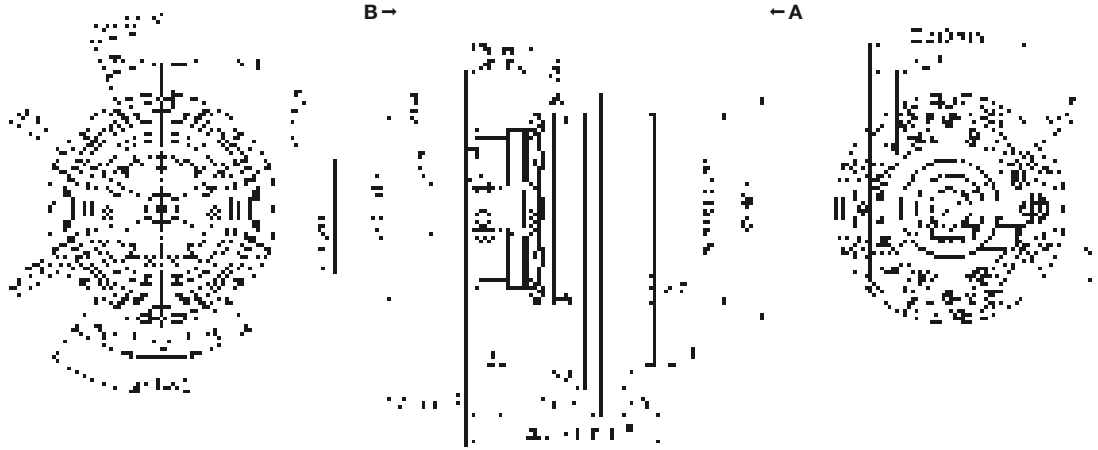

Planetary gearboxes

TP+

MF



Non-tolerated dimensions are nominal dimensions

¹⁾ Check motor shaft fit

²⁾ Min./Max. permissible motor shaft length. Longer motor shafts are possible, please contact alpha.

³⁾ The dimensions depend on the motor

⁴⁾ Smaller motor shaft diameter is compensated by a bushing with a minimum thickness of 1 mm

⁵⁾ Standard clamping hub diameter

TP+ 500 MF 1-stage

			1-stage				
Ratio	i		5	7	8	10	
Max. torque ^{a) b)}	T_{2a}	Nm	9600	6790	4000	4000	
		in.lb	84968	60097	35403	35403	
Max. acceleration torque ^{b)} (max. 1000 cycles per hour)	T_{2B}	Nm	7200	6000	4000	4000	
		in.lb	63726	53105	35403	35403	
Nominal torque (at n_n)	T_{2N}	Nm	3131	2857	2830	2840	
		in.lb	27711	25286	25049	25135	
Emergency stop torque ^{a) b)} (permitted 1000 times during the service life of the gearbox)	T_{2Not}	Nm	15000	15000	15000	15000	
		in.lb	132762	132762	132762	132762	
Permitted average input speed (at T_{2a} and 20 °C ambient temperature) ^{d)}	n_{1N}	rpm	900	1300	1300	1500	
Max. input speed	n_{1Max}	rpm	3000	3000	3000	3000	
Mean no load running torque ^{b)} (at $n_i = 2000$ rpm and 20 °C gearbox temperature)	T_{012}	Nm	27	19	19	12	
		in.lb	242	170	170	110	
Max. backlash	j_t	arcmin	Standard ≤ 3 / Reduced ≤ 1				
Torsional rigidity ^{b)}	C_{t21}	Nm/arcmin	1450	1300	1100	1100	
		in.lb/arcmin	12834	11506	9736	9736	
Tilting rigidity	C_{2K}	Nm/arcmin	9480				
		in.lb/arcmin	83906				
Max. axial force ^{c)}	F_{2AMax}	N	50000				
		lb _f	11250				
Max. tilting moment	M_{2KMax}	Nm	5500				
		in.lb	48679				
Efficiency at full load	η	%	95				
Service life	L_h	h	> 20000				
Weight (incl. standard adapter plate)	m	kg	82				
		lb _m	181.2				
Operating noise (at reference ratio and reference speed – ratio-specific values available in cymex [®])	L_{PA}	dB(A)	≤ 64				
Max. permitted housing temperature		°C	+90				
		F	194				
Ambient temperature		°C	-15 to +40				
		F	5 to 104				
Lubrication			Lubricated for life				
Direction of rotation			In- and output same direction				
Protection class			IP 65				
Metal bellows coupling (recommended product type – validate sizing with cymex [®])			-				
Bore diameter of coupling on the application side		mm	-				
Mass moment of inertia (relates to the drive) Clamping hub diameter [mm] Optimized mass inertia version available on request	O 60	J_1	kgcm ²	182	142	142	120
			10 ⁻³ in.lb.s ²	161	126	126	106

Please use our sizing software cymex[®] for a detailed sizing – www.wittenstein-cymex.com

- ^{a)} At max. 10 % M_{2KMax}
^{b)} Valid for standard clamping hub diameter
^{c)} Refers to center of the output shaft or flange
^{d)} Please reduce input speed at higher ambient temperatures

View A

View B

Motor shaft diameter [mm]

1-stage

up to 60⁴⁾ (O)⁵⁾
clamping hub diameter

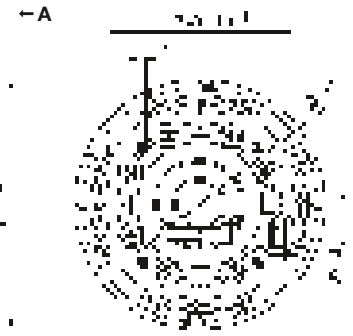
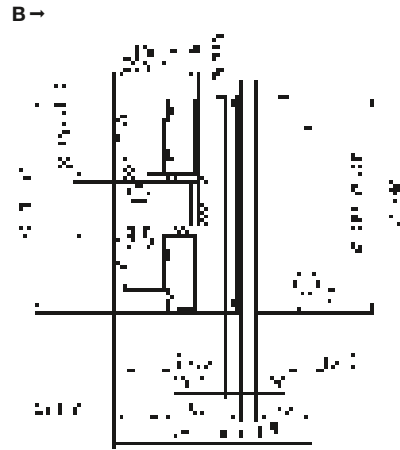
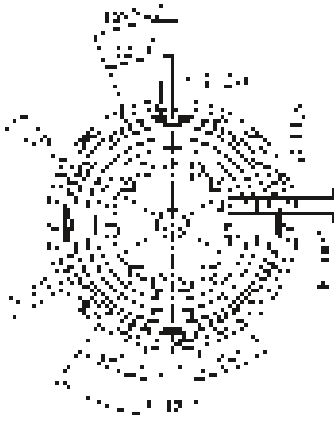

Planetary gearboxes

TP+

MF

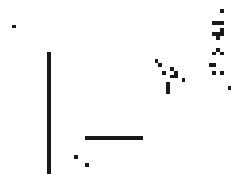

Non-tolerated dimensions are nominal dimensions

¹⁾ Check motor shaft fit

²⁾ Min./Max. permissible motor shaft length. Longer motor shafts are possible, please contact alpha.

³⁾ The dimensions depend on the motor

⁴⁾ Smaller motor shaft diameter is compensated by a bushing with a minimum thickness of 1 mm

⁵⁾ Standard clamping hub diameter

TP+ 500 MF 2-stage

				2-stage												
Ratio	<i>i</i>			20	21	25	31	32	35	50	61	64	70	91	100	
Max. torque ^{a) b)}	T_{2a}	Nm		5446	5718	6808	6354	5500	6808	4975	5280	4800	5500	4800	4800	
		in.lb		48202	50612	60252	56239	48679	60252	44033	46732	42484	48679	42484	42484	
Max. acceleration torque ^{b)} (max. 1000 cycles per hour)	T_{2B}	Nm		5446	5718	6808	6324	5500	6808	4975	5280	4800	5500	4800	4800	
		in.lb		48202	50612	60252	56239	48679	60252	44033	46732	42484	48679	42484	42484	
Nominal torque (at n_n)	T_{2N}	Nm		3026	3270	3729	4086	4376	3828	3697	4224	3840	4400	3840	3840	
		in.lb		26785	28944	33002	36160	38730	33878	32720	37386	33987	38944	33987	33987	
Emergency stop torque ^{a) b)} (permitted 1000 times during the service life of the gearbox)	T_{2Not}	Nm		15000	13928	15000	10854	15000	15000	15000	10678	15000	15000	15000	15000	
		in.lb		132762	123274	132762	96063	132762	132762	132762	94513	132762	132762	132762	132762	
Permitted average input speed (at T_{2a} and 20 °C ambient temperature) ^{d)}	n_{1N}	rpm		1500	1500	1500	1500	1500	1500	2000	2100	2000	2100	2200	2200	
Max. input speed	n_{1Max}	rpm		4375	4375	4375	4375	4375	4375	4375	4375	4375	4375	4375	4375	
Mean no load running torque ^{b)} (at $n_1 = 2000$ rpm and 20 °C gearbox temperature)	T_{012}	Nm		10	9.6	9.2	7.0	9.2	7.0	5.8	3.4	5.8	4.5	3.5	3.6	
		in.lb		92	85	81	62	81	62	51	30	51	40	31	32	
Max. backlash	j_t	arcmin		Standard ≤ 3 / Reduced ≤ 2												
Torsional rigidity ^{b)}	C_{t21}	Nm/arcmin		1400	1200	1450	1200	1450	1400	1300	1100	1300	1250	950	1050	
		in.lb/arcmin		12391	10621	12834	10621	12834	12391	11506	9736	11506	11064	8408	9293	
Tilting rigidity	C_{2K}	Nm/arcmin		9480												
		in.lb/arcmin		83906												
Max. axial force ^{c)}	F_{2AMax}	N		50000												
		lb _f		11250												
Max. tilting moment	M_{2KMax}	Nm		8800												
		in.lb		77887												
Efficiency at full load	η	%		94												
Service life	L_h	h		> 20000												
Weight (incl. standard adapter plate)	<i>m</i>	kg		77.5												
		lb _m		171.3												
Operating noise (at reference ratio and reference speed – ratio-specific values available in cymex [®])	L_{PA}	dB(A)		≤ 60												
Max. permitted housing temperature		°C		+90												
		F		194												
Ambient temperature		°C		-15 to +40												
		F		5 to 104												
Lubrication				Lubricated for life												
Direction of rotation				In- and output same direction												
Protection class				IP 65												
Metal bellows coupling (recommended product type – validate sizing with cymex [®])				-												
Bore diameter of coupling on the application side		mm		-												
Mass moment of inertia (relates to the drive) Clamping hub diameter [mm] Optimized mass inertia version available on request	M	48	J_1	kgcm ²	24.8	35.9	40.2	33.7	35.4	27.4	27.4	25.4	25.8	31.0	25.0	25.2
				10 ⁻³ in.lb.s ²	21.9	31.8	35.6	29.8	31.3	24.2	24.2	22.5	22.8	27.4	22.1	22.3

Please use our sizing software cymex[®] for a detailed sizing – www.wittenstein-cymex.com

^{a)} At max. 10 % M_{2KMax}

^{b)} Valid for standard clamping hub diameter

^{c)} Refers to center of the output shaft or flange

^{d)} Please reduce input speed at higher ambient temperatures

View A

View B

Motor shaft diameter [mm]

2-stage

up to 48⁴⁾ (M)⁵⁾
clamping hub diameter

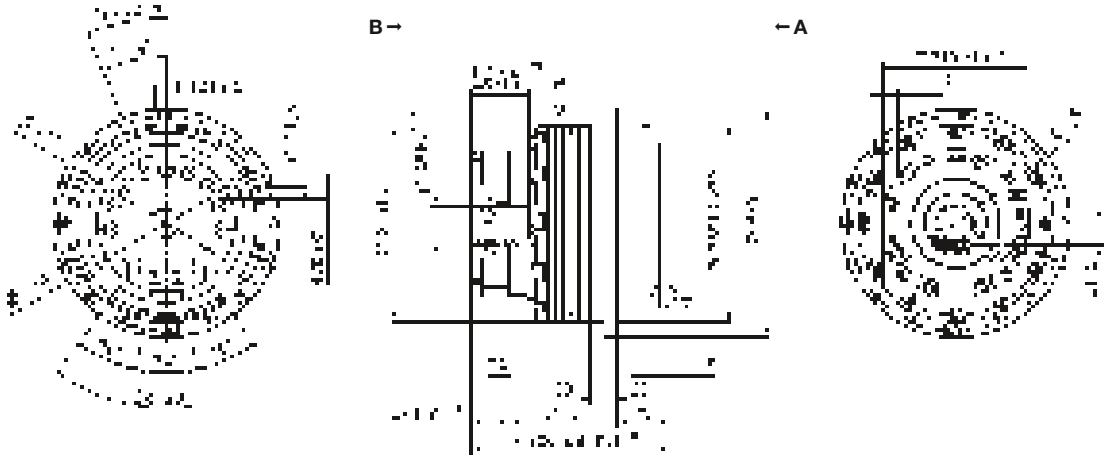

Planetary gearboxes

TP+

MF

Non-tolerated dimensions are nominal dimensions

¹⁾ Check motor shaft fit

²⁾ Min./Max. permissible motor shaft length. Longer motor shafts are possible, please contact alpha.

³⁾ The dimensions depend on the motor

⁴⁾ Smaller motor shaft diameter is compensated by a bushing with a minimum thickness of 1 mm

⁵⁾ Standard clamping hub diameter

TP+ 010 MA 2-/3-stage

			2-stage				3-stage					
Ratio	<i>i</i>		22	27.5	38.5	55	88	110	154	220		
Max. torque ^{a) b)}	T_{2a}	Nm	315	315	315	315	315	315	315	315		
		in.lb	2788	2788	2788	2788	2788	2788	2788	2788		
Max. acceleration torque ^{b)} (max. 1000 cycles per hour)	T_{2B}	Nm	230	230	230	230	230	230	230	230		
		in.lb	2036	2036	2036	2036	2036	2036	2036	2036		
Nominal torque (at n_n)	T_{2N}	Nm	140	137	139	147	184	184	181	184		
		in.lb	1242	1213	1230	1303	1629	1629	1599	1629		
Emergency stop torque ^{a) b)} (permitted 1000 times during the service life of the gearbox)	T_{2Not}	Nm	525	525	525	525	525	525	525	525		
		in.lb	4647	4647	4647	4647	4647	4647	4647	4647		
Permitted average input speed (at T_{2a} and 20 °C ambient temperature) ^{d)}	n_{1N}	rpm	4000	4000	4000	4000	4500	4500	4500	4500		
Max. input speed	n_{1Max}	rpm	7500	7500	7500	7500	7500	7500	7500	7500		
Mean no load running torque ^{b)} (at $n_1 = 3000$ rpm and 20 °C gearbox temperature)	T_{012}	Nm	0.52	0.47	0.38	0.38	0.28	0.26	0.22	0.18		
		in.lb	4.6	4.2	3.4	3.4	2.5	2.3	1.9	1.6		
Max. backlash	j_t	arcmin	≤ 1									
Torsional rigidity ^{b)}	C_{t21}	Nm/arcmin	43	43	43	42	42	42	42	42		
		in.lb/arcmin	381	381	381	372	372	372	372	372		
Tilting rigidity	C_{2K}	Nm/arcmin	225									
		in.lb/arcmin	1991									
Max. axial force ^{c)}	F_{2AMax}	N					2795					
		lb _f					629					
Max. tilting moment	M_{2KMax}	Nm					400					
		in.lb					3540					
Efficiency at full load	η	%	94									
Service life	L_h	h	> 20000									
Weight (incl. standard adapter plate)	<i>m</i>	kg	3.2				3.6					
		lb _m	7.1				8.0					
Operating noise (at reference ratio and reference speed – ratio-specific values available in cymex [®])	L_{PA}	dB(A)	≤ 56									
		°C	+90									
Max. permitted housing temperature		F	194									
		°C	-15 to +40									
Ambient temperature		F	5 to 104									
Lubrication			Lubricated for life									
Direction of rotation			In- and output same direction									
Protection class			IP 65									
Metal bellows coupling (recommended product type – validate sizing with cymex [®])			BCT-00150AAX-050.00									
Bore diameter of coupling on the application side		mm	X = 016.000 - 038.000									
Mass moment of inertia (relates to the drive) Clamping hub diameter [mm] Optimized mass inertia version available on request	C	14	J_1	kgcm ²	0.21	0.18	0.16	0.14	0.16	0.15	0.14	0.13
				10 ⁻³ in.lb.s ²	0.19	0.16	0.14	0.12	0.14	0.13	0.12	0.12
	E	19	J_1	kgcm ²	0.52	0.50	0.47	0.46	-	-	-	-
				10 ⁻³ in.lb.s ²	0.46	0.44	0.42	0.41	-	-	-	-

Please use our sizing software cymex[®] for a detailed sizing – www.wittenstein-cymex.com

^{a)} At max. 10 % M_{2KMax}

^{b)} Valid for standard clamping hub diameter

^{c)} Refers to center of the output shaft or flange

^{d)} Please reduce input speed at higher ambient temperatures

View A

View B

2-stage

up to 14⁴⁾ (C)⁵⁾
clamping hub
diameter

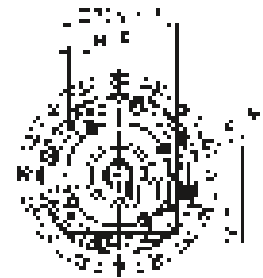
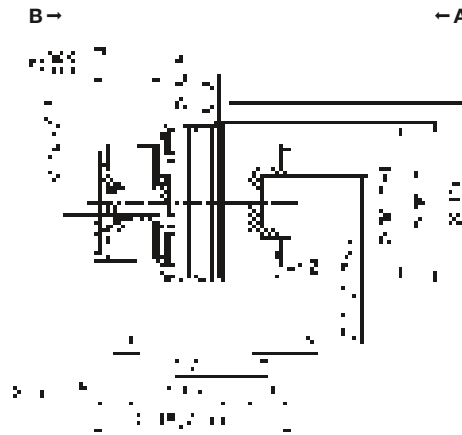
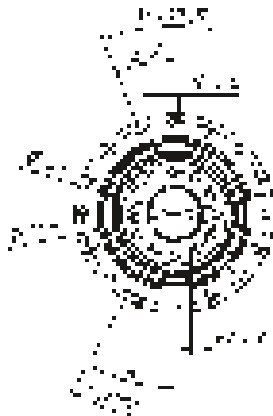

up to 19⁴⁾ (E)
clamping hub
diameter

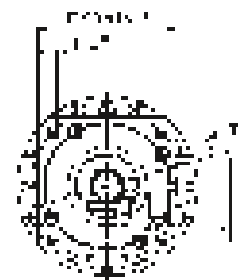
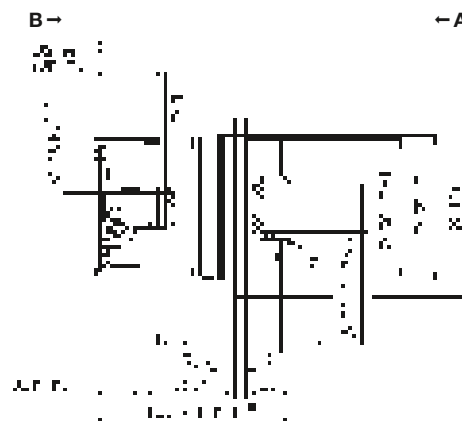
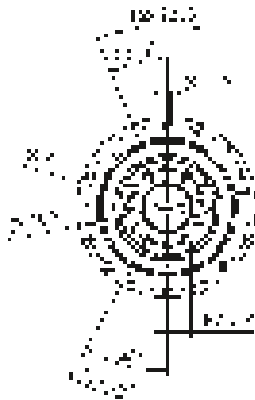

Motor shaft diameter [mm]

3-stage

up to 14⁴⁾ (C)⁵⁾
clamping hub
diameter

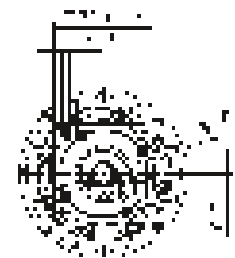
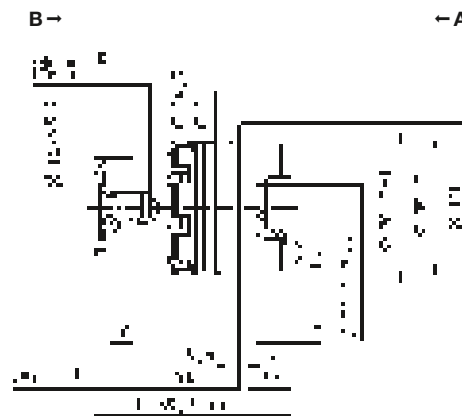
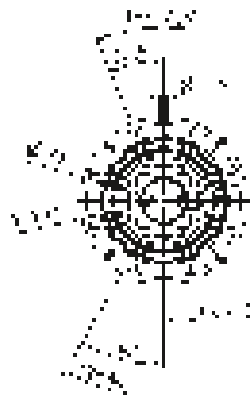

Planetary gearboxes

TP+

MA

Non-tolerated dimensions are nominal dimensions

¹⁾ Check motor shaft fit

²⁾ Min./Max. permissible motor shaft length. Longer motor shafts are possible, please contact alpha.

³⁾ The dimensions depend on the motor

⁴⁾ Smaller motor shaft diameter is compensated by a bushing with a minimum thickness of 1 mm

⁵⁾ Standard clamping hub diameter

TP+ 025 MA 2-/3-stage

			2-stage				3-stage						
Ratio	<i>i</i>		22	27.5	38.5	55	66	88	110	154	220		
Max. torque ^{a) b)}	T_{2a}	Nm	583	583	583	583	525	525	525	525	525		
		in.lb	5160	5160	5160	5160	4645	4645	4645	4645	4645		
Max. acceleration torque ^{b)} (max. 1000 cycles per hour)	T_{2B}	Nm	530	530	530	530	480	480	480	480	480		
		in.lb	4691	4691	4691	4691	4248	4248	4248	4248	4248		
Nominal torque (at n_n)	T_{2N}	Nm	312	314	371	413	260	276	296	330	364		
		in.lb	2762	2775	3286	3652	2304	2447	2617	2920	3222		
Emergency stop torque ^{a) b)} (permitted 1000 times during the service life of the gearbox)	T_{2Not}	Nm	1200	1200	1200	1200	1200	1200	1200	1200	1200		
		in.lb	10621	10621	10621	10621	10621	10621	10621	10621	10621		
Permitted average input speed (at T_{2a} and 20 °C ambient temperature) ^{d)}	n_{1N}	rpm	3500	3500	3500	3500	4000	4000	4000	4000	4000		
Max. input speed	n_{1Max}	rpm	7500	7500	7500	7500	7500	7500	7500	7500	7500		
Mean no load running torque ^{b)} (at $n_1 = 3000$ rpm and 20 °C gearbox temperature)	T_{012}	Nm	1.0	0.87	0.78	0.70	0.62	0.52	0.44	0.35	0.27		
		in.lb	9.2	7.7	6.9	6.2	5.5	4.6	3.9	3.1	2.4		
Max. backlash	j_t	arcmin	≤ 1										
Torsional rigidity ^{b)}	C_{t21}	Nm/arcmin	105	105	105	100	95	95	95	95	95		
		in.lb/arcmin	929	929	929	885	841	841	841	841	841		
Tilting rigidity	C_{2K}	Nm/arcmin	550										
		in.lb/arcmin	4868										
Max. axial force ^{c)}	F_{2AMax}	N	4800										
		lb _f	1080										
Max. tilting moment	M_{2KMax}	Nm	550										
		in.lb	4868										
Efficiency at full load	η	%	94										
Service life	L_h	h	> 20000										
Weight (incl. standard adapter plate)	m	kg	5.6				6.1						
		lb _m	12.4				13.5						
Operating noise (at reference ratio and reference speed – ratio-specific values available in cymex [®])	L_{PA}	dB(A)	≤ 58				≤ 56						
Max. permitted housing temperature		°C	+90										
		F	194										
Ambient temperature		°C	-15 to +40										
		F	5 to 104										
Lubrication			Lubricated for life										
Direction of rotation			In- and output same direction										
Protection class			IP 65										
Metal bellows coupling (recommended product type – validate sizing with cymex [®])			BCT-00300AAX-063.00										
Bore diameter of coupling on the application side		mm	X = 030.000 - 056.000										
Mass moment of inertia (relates to the drive) Clamping hub diameter [mm] Optimized mass inertia version available on request	E	19	J_1	kgcm ²	0.87	0.7	0.6	0.55	0.63	0.56	0.53	0.51	0.50
				10 ⁻³ in.lb.s ²	0.77	0.62	0.53	0.49	0.56	0.50	0.47	0.45	0.44
	G	24	J_1	kgcm ²	2.39	2.22	2.12	2.07	-	-	-	-	-
				10 ⁻³ in.lb.s ²	2.12	1.96	1.88	1.83	-	-	-	-	-

Please use our sizing software cymex[®] for a detailed sizing – www.wittenstein-cymex.com

^{a)} At max. 10 % M_{2KMax}

^{b)} Valid for standard clamping hub diameter

^{c)} Refers to center of the output shaft or flange

^{d)} Please reduce input speed at higher ambient temperatures

View A

View B

2-stage

up to 19⁴⁾ (E)⁵⁾
clamping hub
diameter

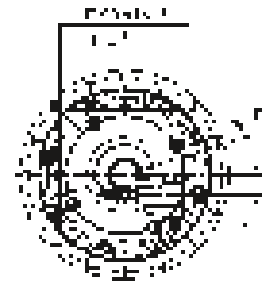
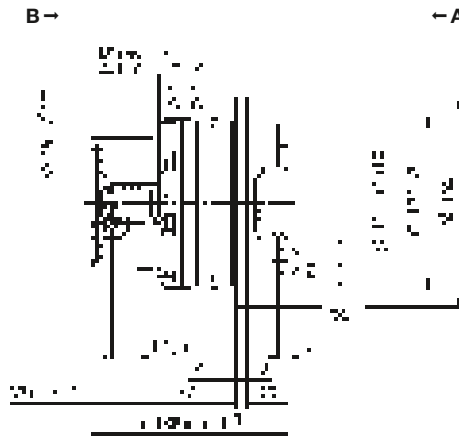
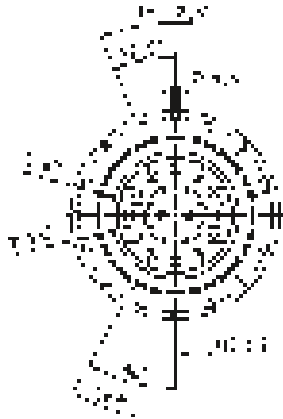

up to 24⁴⁾ (G)
clamping hub
diameter

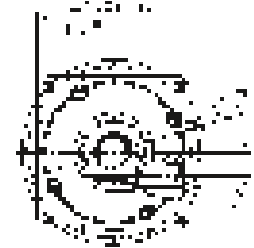
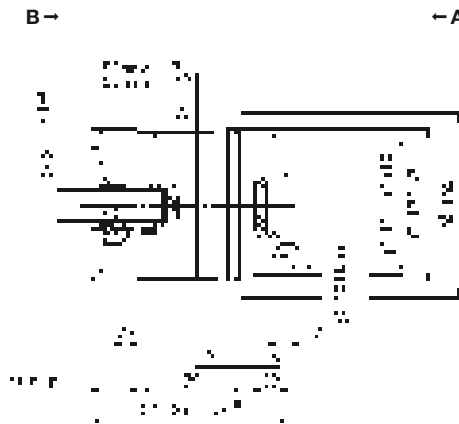
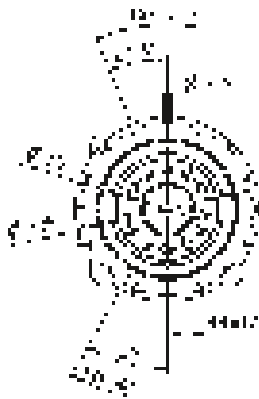

3-stage

up to 19⁴⁾ (E)⁵⁾
clamping hub
diameter

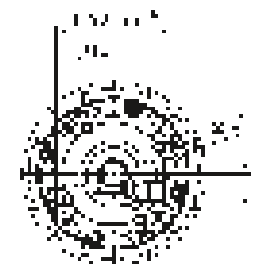
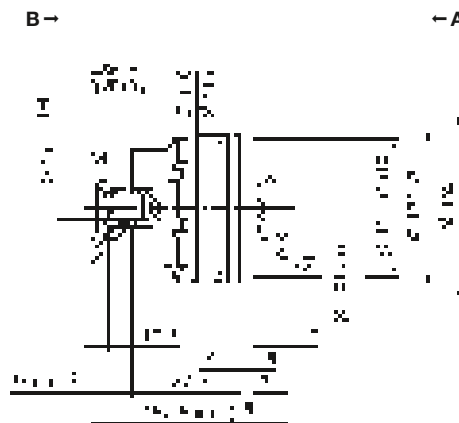
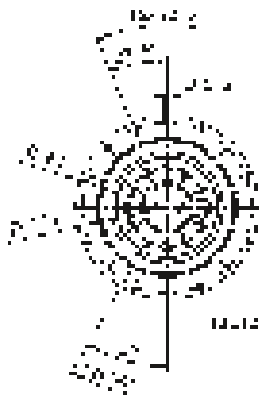

Motor shaft diameter [mm]

Planetary gearboxes

TP+

MA

Non-tolerated dimensions are nominal dimensions

¹⁾ Check motor shaft fit

²⁾ Min./Max. permissible motor shaft length. Longer motor shafts are possible, please contact alpha.

³⁾ The dimensions depend on the motor

⁴⁾ Smaller motor shaft diameter is compensated by a bushing with a minimum thickness of 1 mm

⁵⁾ Standard clamping hub diameter

TP+ 050 MA 2-/3-stage

			2-stage				3-stage						
Ratio	<i>i</i>		22	27.5	38.5	55	66	88	110	154	220		
Max. torque ^{a) b)}	T_{2a}	Nm	1402	1402	1402	1402	1402	1402	1402	1402	1402		
		in.lb	12406	12406	12406	12406	12406	12406	12406	12406	12406		
Max. acceleration torque ^{b)} (max. 1000 cycles per hour)	T_{2B}	Nm	992	992	992	992	992	992	992	992	992		
		in.lb	8780	8780	8780	8780	8780	8780	8780	8780	8780		
Nominal torque (at n_n)	T_{2N}	Nm	523	566	638	717	723	794	794	794	794		
		in.lb	4632	5005	5649	6348	6400	7024	7024	7024	7024		
Emergency stop torque ^{a) b)} (permitted 1000 times during the service life of the gearbox)	T_{2Not}	Nm	2375	2375	2375	2375	2375	2375	2375	2375	2375		
		in.lb	21021	21021	21021	21021	21021	21021	21021	21021	21021		
Permitted average input speed (at T_{2a} and 20 °C ambient temperature) ^{d)}	n_{1N}	rpm	3000	3000	3000	3000	3500	3500	3500	3500	3500		
Max. input speed	n_{1Max}	rpm	6250	6250	6250	6250	6250	6250	6250	6250	6250		
Mean no load running torque ^{b)} (at $n_i = 3000$ rpm and 20 °C gearbox temperature)	T_{012}	Nm	2.7	2.4	2.1	1.7	1.8	1.3	1.1	0.9	0.72		
		in.lb	23.9	21.2	18.9	15.0	15.9	11.5	10.1	8.0	6.4		
Max. backlash	j_t	arcmin	≤ 1										
Torsional rigidity ^{b)}	C_{t21}	Nm/arcmin	220	220	220	220	205	205	205	205	205		
		in.lb/arcmin	1947	1947	1947	1947	1814	1814	1814	1814	1814		
Tilting rigidity	C_{2K}	Nm/arcmin	560										
		in.lb/arcmin	4956										
Max. axial force ^{c)}	F_{2AMax}	N	6130										
		lb _f	1379										
Max. tilting moment	M_{2KMax}	Nm	1335										
		in.lb	11816										
Efficiency at full load	η	%	94				92						
Service life	L_h	h	> 20000										
Weight (incl. standard adapter plate)	m	kg	12.5				13.4						
		lb _m	27.6				29.6						
Operating noise (at reference ratio and reference speed – ratio-specific values available in cymex [®])	L_{PA}	dB(A)	≤ 60				≤ 57						
Max. permitted housing temperature		°C	+90										
		F	194										
Ambient temperature		°C	-15 to +40										
		F	5 to 104										
Lubrication			Lubricated for life										
Direction of rotation			In- and output same direction										
Protection class			IP 65										
Metal bellows coupling (recommended product type – validate sizing with cymex [®])			BCT-00300AAX-080.00										
Bore diameter of coupling on the application side		mm	X = 045.000 - 056.000										
Mass moment of inertia (relates to the drive) Clamping hub diameter [mm] Optimized mass inertia version available on request	G	24	J_1	kgcm ²	3.80	3.33	3.00	2.80	2.60	2.40	2.20	2.10	2.10
				10 ⁻³ in.lb.s ²	3.36	2.95	2.66	2.48	2.30	2.10	1.90	1.90	1.90
	K	38	J_1	kgcm ²	10.7	10.3	9.90	9.70	-	-	-	-	-
				10 ⁻³ in.lb.s ²	9.47	9.12	8.76	8.58	-	-	-	-	-

Please use our sizing software cymex[®] for a detailed sizing – www.wittenstein-cymex.com

^{a)} At max. 10 % M_{2KMax}

^{b)} Valid for standard clamping hub diameter

^{c)} Refers to center of the output shaft or flange

^{d)} Please reduce input speed at higher ambient temperatures

View A

View B

2-stage

up to 24⁴⁾ (G)⁵⁾
clamping hub
diameter

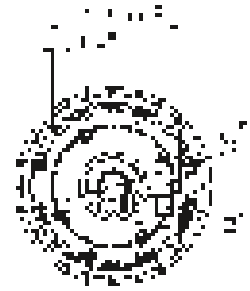
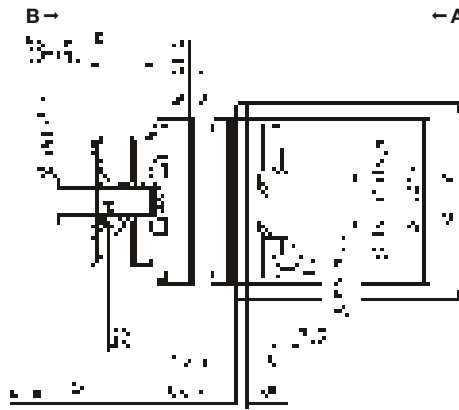
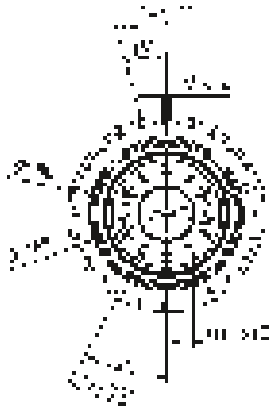

up to 38⁴⁾ (K)
clamping hub
diameter

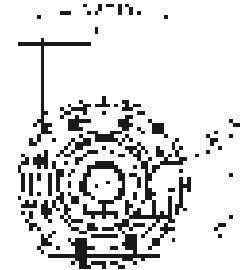
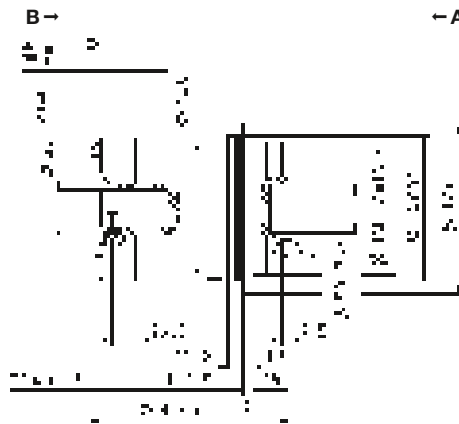
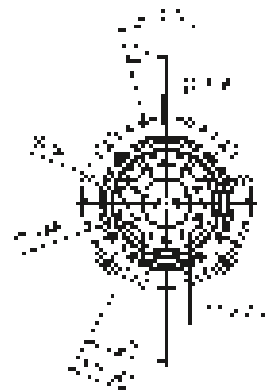

Motor shaft diameter [mm]

3-stage

up to 24⁴⁾ (G)⁵⁾
clamping hub
diameter

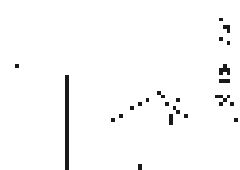
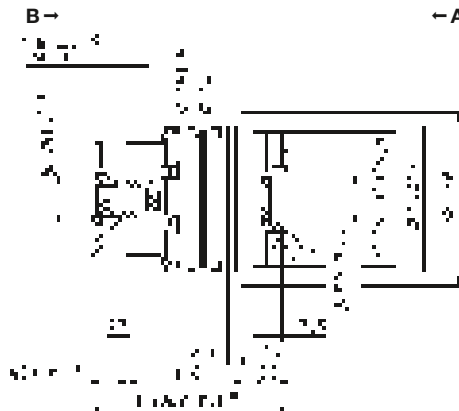
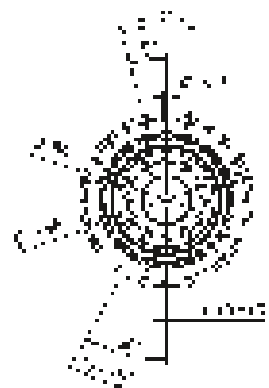

Planetary gearboxes

TP+

MA

Non-tolerated dimensions are nominal dimensions

¹⁾ Check motor shaft fit

²⁾ Min./Max. permissible motor shaft length. Longer motor shafts are possible, please contact alpha.

³⁾ The dimensions depend on the motor

⁴⁾ Smaller motor shaft diameter is compensated by a bushing with a minimum thickness of 1 mm

⁵⁾ Standard clamping hub diameter

TP+ 110 MA 2-/3-stage

			2-stage				3-stage						
Ratio	<i>i</i>		22	27.5	38.5	55	66	88	110	154	220		
Max. torque ^{a) b)}	T_{2a}	Nm	3822	3822	3822	3200	3023	3023	3023	3023	3023		
		in.lb	33826	33826	33826	28323	26757	26757	26757	26757	26757		
Max. acceleration torque ^{b)} (max. 1000 cycles per hour)	T_{2B}	Nm	3100	3100	3100	2400	2600	2600	2600	2600	2600		
		in.lb	27437	27437	27437	21242	23012	23012	23012	23012	23012		
Nominal torque (at n_n)	T_{2N}	Nm	1546	1662	2149	1827	1649	1797	1924	2080	2080		
		in.lb	13687	14708	19022	16169	14593	15909	17033	18410	18410		
Emergency stop torque ^{a) b)} (permitted 1000 times during the service life of the gearbox)	T_{2Not}	Nm	6500	6500	6500	6500	6500	6500	6500	6500	6500		
		in.lb	57530	57530	57530	57530	57530	57530	57530	57530	57530		
Permitted average input speed (at T_{2a} and 20 °C ambient temperature) ^{d)}	n_{1N}	rpm	2500	2500	2500	2500	3000	3000	3000	3000	3000		
Max. input speed	n_{1Max}	rpm	5625	5625	5625	5625	5625	5625	5625	5625	5625		
Mean no load running torque ^{b)} (at $n_1 = 3000$ rpm and 20 °C gearbox temperature)	T_{012}	Nm	6.1	5.5	4.8	4.3	3.8	3.0	2.6	1.8	1.6		
		in.lb	54.0	48.7	42.5	38.1	33.6	26.9	23	15.6	14.2		
Max. backlash	j_t	arcmin	≤ 1										
Torsional rigidity ^{b)}	C_{t21}	Nm/arcmin	730	725	715	670	650	650	650	650	650		
		in.lb/arcmin	6461	6417	6328	5930	5753	5753	5753	5753	5753		
Tilting rigidity	C_{2K}	Nm/arcmin	1452										
		in.lb/arcmin	12851										
Max. axial force ^{c)}	F_{2AMax}	N	10050										
		lb _f	2261										
Max. tilting moment	M_{2KMax}	Nm	3280										
		in.lb	29031										
Efficiency at full load	η	%	94										
Service life	L_h	h	> 20000										
Weight (incl. standard adapter plate)	m	kg	33.1				35.4						
		lb _m	73.2				78.2						
Operating noise (at reference ratio and reference speed – ratio-specific values available in cymex [®])	L_{PA}	dB(A)	≤ 61				≤ 59						
Max. permitted housing temperature		°C	+90										
		F	194										
Ambient temperature		°C	-15 to +40										
		F	5 to 104										
Lubrication			Lubricated for life										
Direction of rotation			In- and output same direction										
Protection class			IP 65										
Metal bellows coupling (recommended product type – validate sizing with cymex [®])			BCT-01500AAX-125.00										
Bore diameter of coupling on the application side		mm	X = 055.000 - 070.000										
Mass moment of inertia (relates to the drive) Clamping hub diameter [mm] Optimized mass inertia version available on request	K	38	J_1	kgcm ²	16.6	15.2	13.9	13.1	13.8	10.2	9.80	9.50	9.20
				10 ⁻³ in.lb.s ²	14.7	13.5	12.3	11.6	12.2	9.00	8.70	8.40	8.10
	M	48	J_1	kgcm ²	31.4	29.9	28.7	28.0	-	-	-	-	-
				10 ⁻³ in.lb.s ²	27.8	26.5	25.4	24.8	-	-	-	-	-

Please use our sizing software cymex[®] for a detailed sizing – www.wittenstein-cymex.com

^{a)} At max. 10 % M_{2KMax}

^{b)} Valid for standard clamping hub diameter

^{c)} Refers to center of the output shaft or flange

^{d)} Please reduce input speed at higher ambient temperatures

View A

View B

2-stage

up to 38⁴⁾ (K)⁵⁾
clamping hub diameter

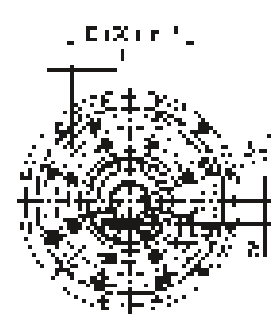
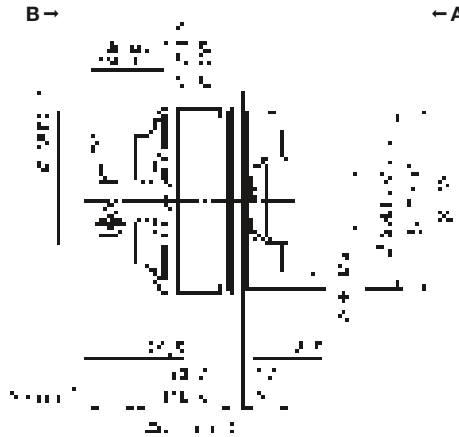
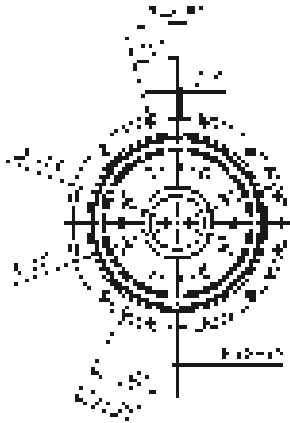

up to 48⁴⁾ (M)
clamping hub diameter

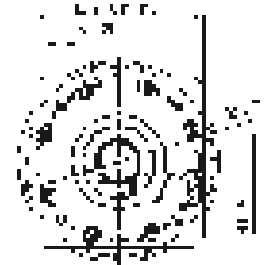
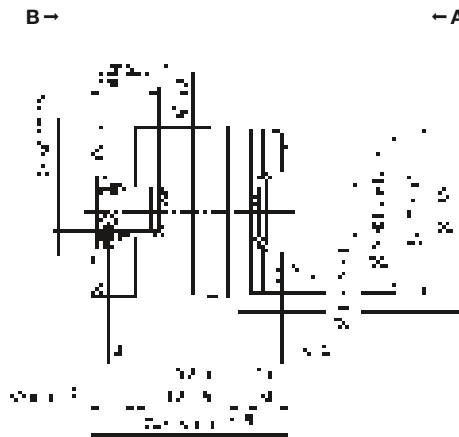
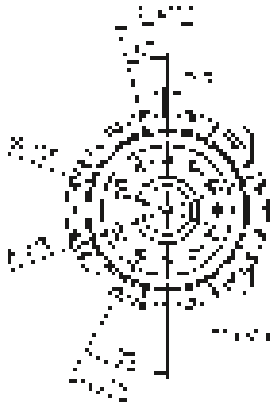

Motor shaft diameter [mm]

3-stage

up to 38⁴⁾ (K)⁵⁾
clamping hub diameter

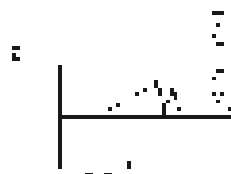
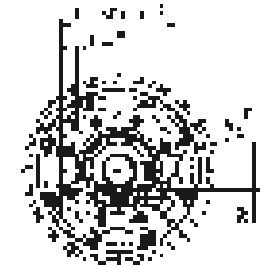
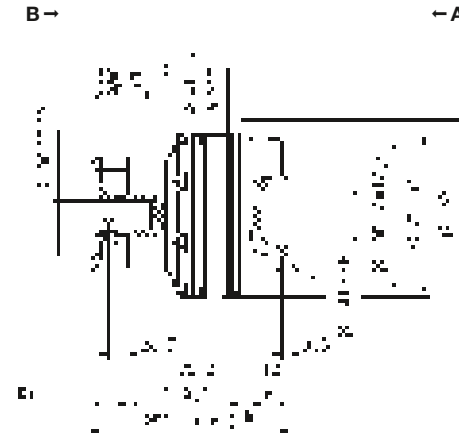
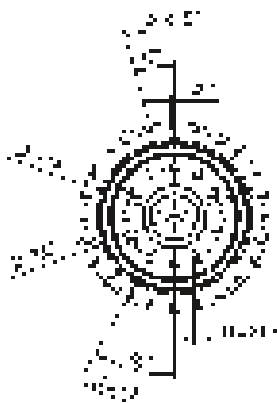

Planetary gearboxes

TP*

MA

Non-tolerated dimensions are nominal dimensions

¹⁾ Check motor shaft fit

²⁾ Min./Max. permissible motor shaft length. Longer motor shafts are possible, please contact alpha.

³⁾ The dimensions depend on the motor

⁴⁾ Smaller motor shaft diameter is compensated by a bushing with a minimum thickness of 1 mm

⁵⁾ Standard clamping hub diameter

TP+ 300 MA 1-/2-/3-stage

				1-stage	2-stage				3-stage					
Ratio	<i>i</i>			5.5	22	27.5	38.5	55	66	88	110	154	220	
Max. torque ^{a) b)}	T_{2a}	<i>Nm</i>		7360	7535	7535	7535	5473	6987	6987	6987	6987	6987	
		<i>in.lb</i>		65142	66691	66691	66691	48436	61838	61838	61838	61838	61838	61838
Max. acceleration torque ^{b)} (max. 1000 cycles per hour)	T_{2B}	<i>Nm</i>		5520	6600	6600	6600	4680	6600	6600	6600	6600	6600	
		<i>in.lb</i>		48856	58415	58415	58415	41422	58415	58415	58415	58415	58415	58415
Nominal torque (at n_n)	T_{2N}	<i>Nm</i>		2829	3566	3788	3884	3744	3216	3506	3750	4148	4617	
		<i>in.lb</i>		25035	31563	33530	34378	33137	28465	31035	33186	36711	40863	
Emergency stop torque ^{a) b)} (permitted 1000 times during the service life of the gearbox)	T_{2Not}	<i>Nm</i>		10938	15333	15333	15296	15333	15333	15333	15333	15333	15333	
		<i>in.lb</i>		96806	135709	135709	135377	135709	135709	135709	135709	135709	135709	135709
Permitted average input speed (at T_{2a} and 20 °C ambient temperature) ^{d)}	n_{1N}	<i>rpm</i>		1000	2000	2000	2000	2000	2000	2000	2000	2000	2000	
Max. input speed	n_{1Max}	<i>rpm</i>		3125	4375	4375	4375	4375	4375	4375	4375	4375	4375	
Mean no load running torque ^{b)} (at $n_i = 2000$ rpm and 20 °C gearbox temperature)	T_{012}	<i>Nm</i>		19	8.8	7.8	6.8	5.9	5.2	3.6	3.1	2.1	1.5	
		<i>in.lb</i>		170	78	69	60	52	46	32	27	19	13	
Max. backlash	j_t	<i>arcmin</i>		Standard ≤ 2 / Reduced ≤ 1	Standard ≤ 3 / Reduced ≤ 1.5									
Torsional rigidity ^{b)}	C_{t21}	<i>Nm/arcmin</i>		1200	1200	1200	1200	1200	1200	1200	1200	1200	1200	
		<i>in.lb/arcmin</i>		10621	10621	10621	10621	10621	10621	10621	10621	10621	10621	
Tilting rigidity	C_{2K}	<i>Nm/arcmin</i>		5560										
		<i>in.lb/arcmin</i>		49210										
Max. axial force ^{c)}	F_{2AMax}	<i>N</i>		33000										
		<i>lb_f</i>		7425										
Max. tilting moment	M_{2KMax}	<i>Nm</i>		3900	6500									
		<i>in.lb</i>		34518	57530									
Efficiency at full load	η	%		95	93									
Service life	L_h	<i>h</i>		> 20000										
Weight (incl. standard adapter plate)	<i>m</i>	<i>kg</i>		55	64				67					
		<i>lb_m</i>		122	141				148					
Operating noise (at reference ratio and reference speed – ratio-specific values available in cymex [®])	L_{PA}	<i>dB(A)</i>		≤ 65	≤ 62				≤ 59					
Max. permitted housing temperature		°C		+90										
		F		194										
Ambient temperature		°C		-15 to +40										
		F		5 to 104										
Lubrication				Lubricated for life										
Direction of rotation				In- and output same direction										
Protection class				IP 65										
Metal bellows coupling (recommended product type – validate sizing with cymex [®])				BCT-04000AAX-145.00										
Bore diameter of coupling on the application side		<i>mm</i>		X = 070.000 - 100.000										
Mass moment of inertia (relates to the drive) Clamping hub diameter [mm] Optimized mass inertia version available on request	K	38	J_1	<i>kgcm²</i>	-	-	-	-	-	16.6	12.9	11.6	10.3	9.50
				<i>10⁻³ in.lb.s²</i>	-	-	-	-	-	14.7	11.4	10.3	9.10	8.40
	M	48	J_1	<i>kgcm²</i>	-	30.8	27.6	24.9	23.0	-	-	-	-	-
				<i>10⁻³ in.lb.s²</i>	-	27.3	24.4	22.0	20.4	-	-	-	-	-
	N	55	J_1	<i>kgcm²</i>	129	-	-	-	-	-	-	-	-	-
				<i>10⁻³ in.lb.s²</i>	114	-	-	-	-	-	-	-	-	-

Please use our sizing software cymex[®] for a detailed sizing – www.wittenstein-cymex.com

^{a)} At max. 10 % M_{2KMax}

^{b)} Valid for standard clamping hub diameter

^{c)} Refers to center of the output shaft or flange

^{d)} Please reduce input speed at higher ambient temperatures

View A

View B

1-stage

up to 55⁴⁾ (N)⁵⁾
clamping hub diameter

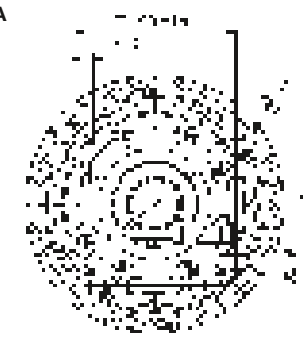
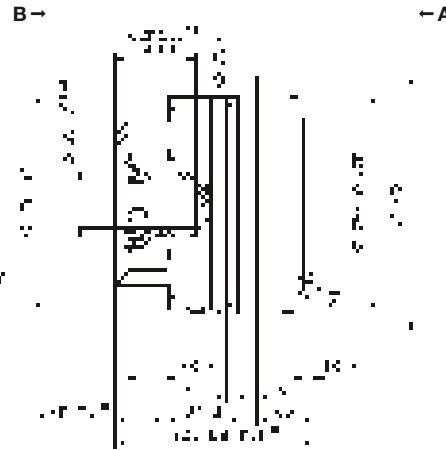
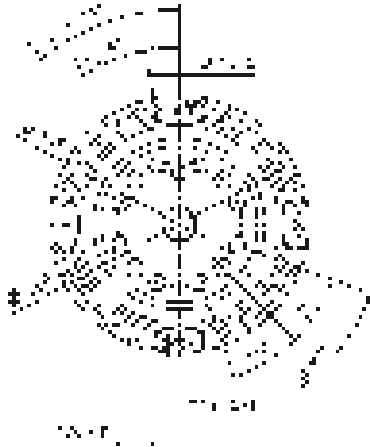

2-stage

up to 48⁴⁾ (M)⁵⁾
clamping hub diameter

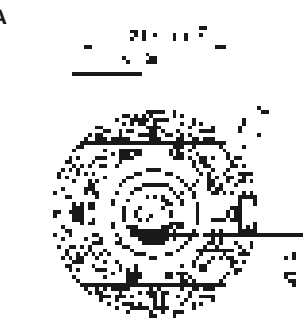
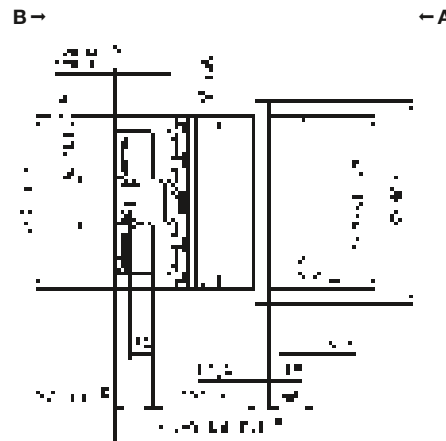
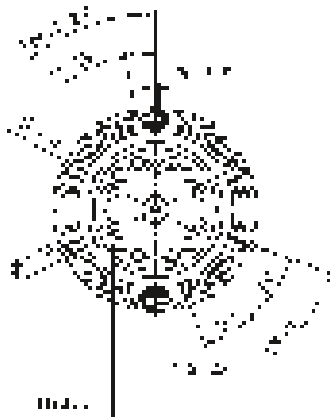

3-stage

up to 38⁴⁾ (K)⁵⁾
clamping hub diameter

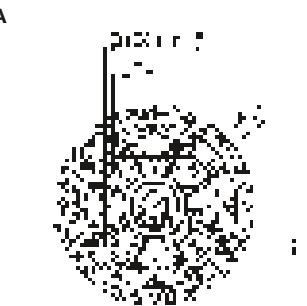
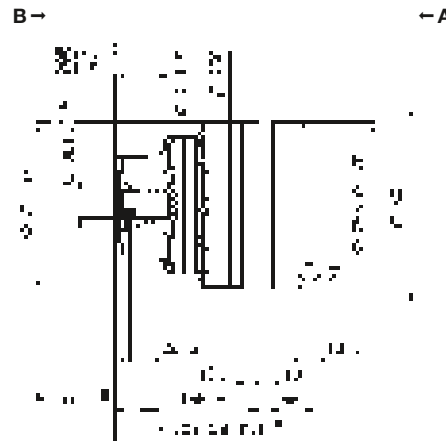
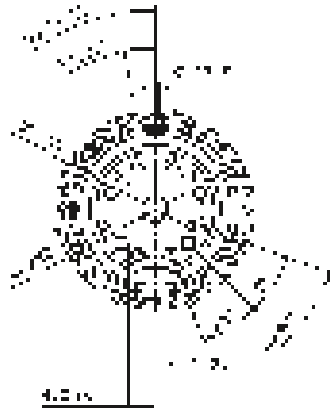

Motor shaft diameter [mm]

Planetary gearboxes

TP+

MA

Non-tolerated dimensions are nominal dimensions

¹⁾ Check motor shaft fit

²⁾ Min./Max. permissible motor shaft length. Longer motor shafts are possible, please contact alpha.

³⁾ The dimensions depend on the motor

⁴⁾ Smaller motor shaft diameter is compensated by a bushing with a minimum thickness of 1 mm

⁵⁾ Standard clamping hub diameter

TP+ 500 MA 1-/2-/3-stage

				1-stage	2-stage				3-stage					
Ratio	<i>i</i>			5.5	22	27.5	38.5	55	66	88	110	154	220	
Max. torque ^{a) b)}	T_{2a}	Nm		10450	10450	10450	10450	10450	10450	10450	10450	10450	10450	
		in.lb		92491	92491	92491	92491	92491	92491	92491	92491	92491	92491	
Max. acceleration torque ^{b)} (max. 1000 cycles per hour)	T_{2B}	Nm		9600	10450	10450	10450	8640	10450	10450	10450	10450	10450	
		in.lb		84968	92491	92491	92491	76471	92491	92491	92491	92491	92491	
Nominal torque (at n_n)	T_{2N}	Nm		4313	5068	4980	5057	5325	4941	7464	7396	7546	7907	
		in.lb		38174	44858	44075	44759	47129	43731	66060	65462	66792	69986	
Emergency stop torque ^{a) b)} (permitted 1000 times during the service life of the gearbox)	T_{2Not}	Nm		18750	25000	25000	25000	25000	25000	25000	25000	25000	25000	
		in.lb		165953	221270	221270	221270	221270	221270	221270	221270	221270	221270	
Permitted average input speed (at T_{2a} and 20 °C ambient temperature) ^{d)}	n_{1N}	rpm		900	1500	1500	1500	1500	1500	1500	1500	1500	1500	
Max. input speed	n_{1Max}	rpm		3125	4375	4375	4375	4375	4375	4375	4375	4375	4375	
Mean no load running torque ^{b)} (at $n_i = 2000$ rpm and 20 °C gearbox temperature)	T_{012}	Nm		27	11	10	8.9	7.8	6.8	5.0	4.7	3.6	3.0	
		in.lb		241	100	89	79	69	60	45	42	32	27	
Max. backlash	j_t	arcmin		Standard ≤ 2 / Reduced ≤ 1	Standard ≤ 3 / Reduced ≤ 1.5									
Torsional rigidity ^{b)}	C_{t21}	Nm/arcmin		2000	2000	2000	1950	1900	1800	1800	1800	1800	1800	
		in.lb/arcmin		17702	17702	17702	17259	16817	15931	15931	15931	15931	15931	
Tilting rigidity	C_{2K}	Nm/arcmin		9480										
		in.lb/arcmin		83906										
Max. axial force ^{c)}	F_{2AMax}	N		50000										
		lb _f		11250										
Max. tilting moment	M_{2KMax}	Nm		6600	9500									
		in.lb		58415	84083									
Efficiency at full load	η	%		95	93									
Service life	L_h	h		> 20000										
Weight (incl. standard adapter plate)	m	kg		80	80				89					
		lb _m		177	177				197					
Operating noise (at reference ratio and reference speed – ratio-specific values available in cymex [®])	L_{PA}	dB(A)		≤ 70	≤ 63				≤ 60					
Max. permitted housing temperature		°C		+90										
		F		194										
Ambient temperature		°C		-15 to +40										
		F		5 to 104										
Lubrication				Lubricated for life										
Direction of rotation				In- and output same direction										
Protection class				IP 65										
Metal bellows coupling (recommended product type – validate sizing with cymex [®])				BCT-10000AAX-166.00										
Bore diameter of coupling on the application side		mm		X = 080.000 - 180.000										
Mass moment of inertia (relates to the drive) Clamping hub diameter [mm] Optimized mass inertia version available on request	K	38	J_1	kgcm ²	-	-	-	-	-	17.9	13.5	11.9	10.5	9.70
				10 ⁻³ in.lb.s ²	-	-	-	-	-	15.8	11.9	10.5	9.30	8.60
	M	48	J_1	kgcm ²	-	43.8	36.9	30.5	27.0	32.7	28.3	26.7	25.2	24.4
				10 ⁻³ in.lb.s ²	-	38.8	32.7	27.0	23.9	28.9	25.0	23.6	22.3	21.6
	O	60	J_1	kgcm ²	175	-	-	-	-	-	-	-	-	-
				10 ⁻³ in.lb.s ²	155	-	-	-	-	-	-	-	-	-

Please use our sizing software cymex[®] for a detailed sizing – www.wittenstein-cymex.com

^{a)} At max. 10 % M_{2KMax}

^{b)} Valid for standard clamping hub diameter

^{c)} Refers to center of the output shaft or flange

^{d)} Please reduce input speed at higher ambient temperatures

View A

View B

1-stage

up to 60⁴⁾ (O)⁵⁾
clamping hub diameter

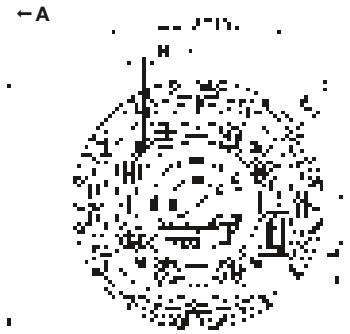
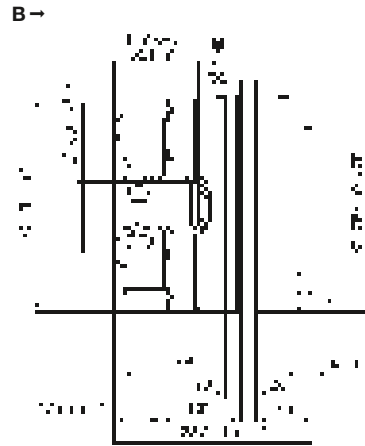
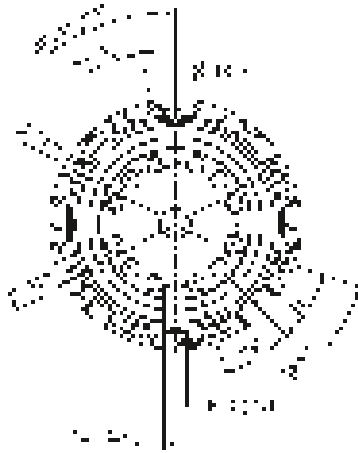

2-stage

up to 48⁴⁾ (M)⁵⁾
clamping hub diameter

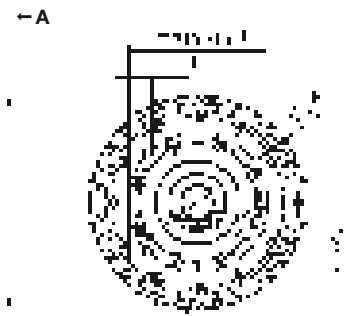
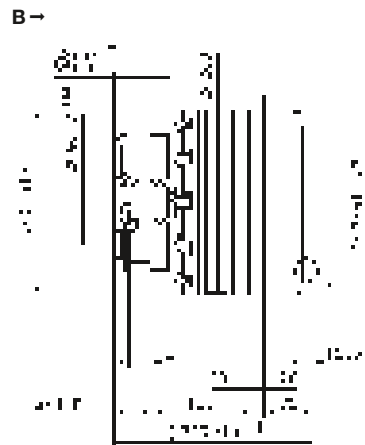
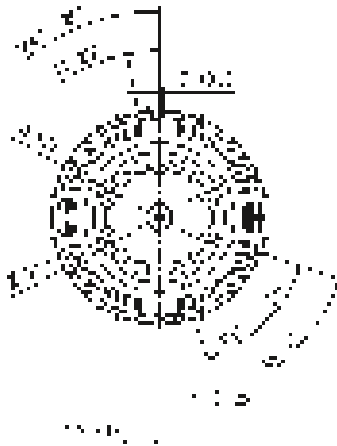

3-stage

up to 38/48⁴⁾
(K/M)⁵⁾ clamping hub diameter

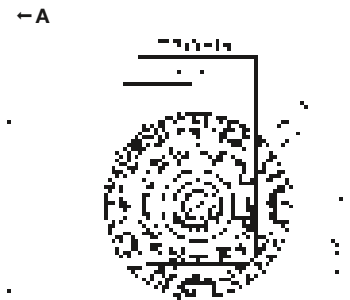
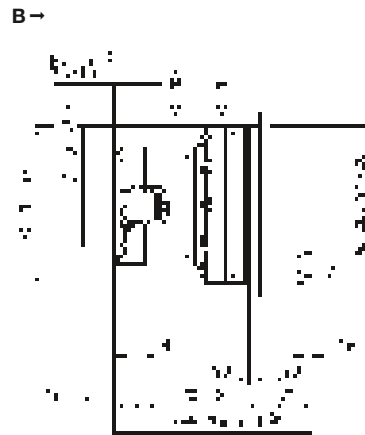
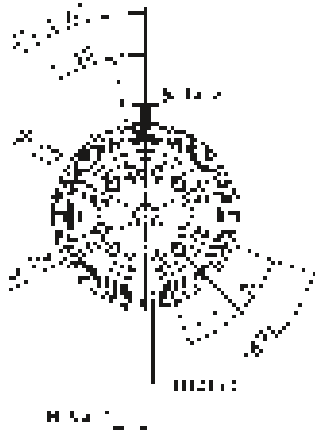

Motor shaft diameter [mm]

Planetary gearboxes

TP+

MA

Non-tolerated dimensions are nominal dimensions

¹⁾ Check motor shaft fit

²⁾ Min./Max. permissible motor shaft length. Longer motor shafts are possible, please contact alpha.

³⁾ The dimensions depend on the motor

⁴⁾ Smaller motor shaft diameter is compensated by a bushing with a minimum thickness of 1 mm

⁵⁾ Standard clamping hub diameter

TP+ 2000 MA 2-/3-stage

			2-stage		3-stage								
Ratio	<i>i</i>		22	30.25	66	88	110	121	154	220	302.5		
Max. torque ^{a) b)}	T_{2a}	Nm	22000	22000	22000	22000	22000	22000	22000	15600	21500		
		in.lb	194718	194718	194718	194718	194718	194718	194718	138072	190292		
Max. acceleration torque ^{b)} (max. 1000 cycles per hour)	T_{2B}	Nm	22000	22000	22000	22000	22000	22000	22000	15600	21500		
		in.lb	194718	194718	194718	194718	194718	194718	194718	138072	190292		
Nominal torque (at n_n)	T_{2N}	Nm	13500	13500	13500	13500	13500	13500	13500	10000	13500		
		in.lb	119486	119486	119486	119486	119486	119486	119486	88508	119486		
Emergency stop torque ^{a) b)} (permitted 1000 times during the service life of the gearbox)	T_{2Not}	Nm	44000	44000	44000	44000	44000	44000	44000	44000	44000		
		in.lb	389435	389435	389435	389435	389435	389435	389435	389435	389435		
Permitted average input speed (at T_{2a} and 20 °C ambient temperature) ^{d)}	n_{1N}	rpm	2000	2000	2500	2500	2500	2500	2500	2500	2500		
Max. input speed	n_{1Max}	rpm	3000	3000	3500	3500	3500	3500	3500	3500	3500		
Mean no load running torque ^{b)} (at $n_i = 2000$ rpm and 20 °C gearbox temperature)	T_{012}	Nm	17	13	7.5	6.0	5.0	5.0	4.5	4.0	4.0		
		in.lb	151	115	66	53	44	44	40	35	35		
Max. backlash	j_t	arcmin	≤ 3										
Torsional rigidity ^{b)}	C_{t21}	Nm/arcmin	2900	2900	3000	3000	3000	3000	2950	2850	2850		
		in.lb/arcmin	25667	25667	26552	26552	26552	26552	26110	25225	25225		
Tilting rigidity	C_{2K}	Nm/arcmin	13000										
		in.lb/arcmin	115060										
Max. axial force ^{c)}	F_{2AMax}	N	100000										
		lb _f	22500										
Max. tilting moment	M_{2KMax}	Nm	31600										
		in.lb	279685										
Efficiency at full load	η	%	95										
Service life	L_h	h	> 20000										
Weight (incl. standard adapter plate)	<i>m</i>	kg	190			185							
		lb _m	420			409							
Operating noise (at reference ratio and reference speed – ratio-specific values available in cymex [®])	L_{PA}	dB(A)	≤ 68			≤ 66							
		°C	+90										
Max. permitted housing temperature		F	194										
		°C	0 to +40										
Ambient temperature		F	32 to 104										
			Lubricated for life										
Lubrication			Lubricated for life										
Direction of rotation			In- and output same direction										
Protection class			IP 65										
Metal bellows coupling (recommended product type – validate sizing with cymex [®])			-										
Bore diameter of coupling on the application side		mm	-										
Mass moment of inertia (relates to the drive) Clamping hub diameter [mm] Optimized mass inertia version available on request	M	48	J_1	kgcm ²	-	-	52	37	35	35	28	26	25
				10 ⁻³ in.lb.s ²	-	-	46	33	31	31	25	23	22
	N	55	J_1	kgcm ²	101	74	-	-	-	-	-	-	-
				10 ⁻³ in.lb.s ²	89	65	-	-	-	-	-	-	-

Please use our sizing software cymex[®] for a detailed sizing – www.wittenstein-cymex.com

- ^{a)} At max. 10 % M_{2KMax}
- ^{b)} Valid for standard clamping hub diameter
- ^{c)} Refers to center of the output shaft or flange
- ^{d)} Please reduce input speed at higher ambient temperatures

View A

View B

2-stage

up to 55⁴⁾ (N)⁵⁾
clamping hub
diameter

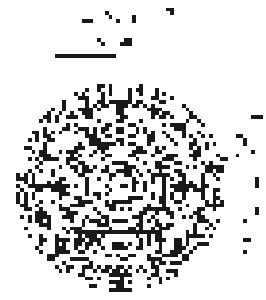
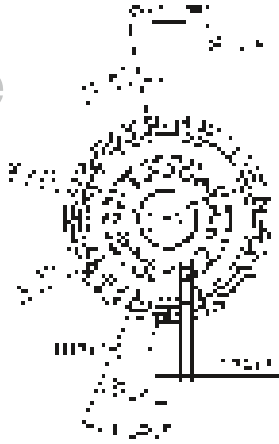

Motor shaft diameter [mm]

3-stage

up to 48⁴⁾ (M)⁵⁾
clamping hub
diameter

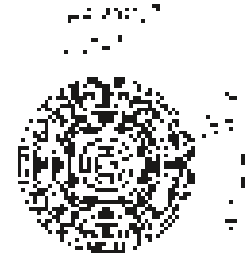
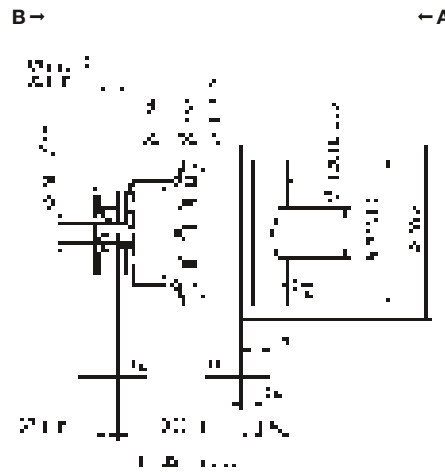
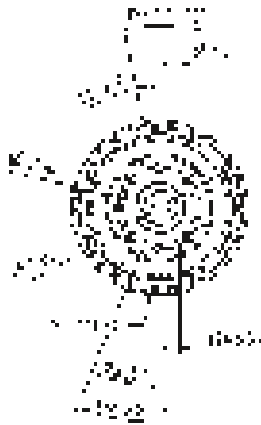

Planetary gearboxes

TP+

MA



Non-tolerated dimensions are nominal dimensions

¹⁾ Check motor shaft fit

²⁾ Min./Max. permissible motor shaft length. Longer motor shafts are possible, please contact alpha.

³⁾ The dimensions depend on the motor

⁴⁾ Smaller motor shaft diameter is compensated by a bushing with a minimum thickness of 1 mm

⁵⁾ Standard clamping hub diameter

TP+ 4000 MA 2-/3-stage

			2-stage		3-stage								
Ratio	<i>i</i>		22	30.25	66	88	110	121	154	220	302.5		
Max. torque ^{a) b)}	T_{2a}	Nm	40000	40000	40000	40000	40000	40000	40000	32000	40000		
		in.lb	354032	354032	354032	354032	354032	354032	354032	283226	354032		
Max. acceleration torque ^{b)} (max. 1000 cycles per hour)	T_{2B}	Nm	40000	40000	40000	40000	40000	40000	40000	32000	40000		
		in.lb	354032	354032	354032	354032	354032	354032	354032	283226	354032		
Nominal torque (at n_n)	T_{2N}	Nm	18000	18000	18000	18000	18000	18000	18000	16500	18000		
		in.lb	159314	159314	159314	159314	159314	159314	159314	146038	159314		
Emergency stop torque ^{a) b)} (permitted 1000 times during the service life of the gearbox)	T_{2Not}	Nm	70000	70000	70000	70000	70000	70000	70000	61000	70000		
		in.lb	619556	619556	619556	619556	619556	619556	619556	539899	619556		
Permitted average input speed (at T_{2a} and 20 °C ambient temperature) ^{d)}	n_{1N}	rpm	1500	1500	1500	1500	1500	1500	1500	1500	1500		
Max. input speed	n_{1Max}	rpm	3000	3000	3000	3000	3000	3000	3000	3000	3000		
Mean no load running torque ^{b)} (at $n_1 = 2000$ rpm and 20 °C gearbox temperature)	T_{012}	Nm	26	21	15	12	10	10	8.5	7.5	7.5		
		in.lb	230	186	133	106	89	89	75	66	66		
Max. backlash	j_t	arcmin	≤ 4										
Torsional rigidity ^{b)}	C_{t21}	Nm/arcmin	5300	5300	5800	5800	5800	5800	5700	5700	5700		
		in.lb/arcmin	46909	46909	51335	51335	51335	51335	50450	50450	50450		
Tilting rigidity	C_{2K}	Nm/arcmin	65000										
		in.lb/arcmin	575302										
Max. axial force ^{c)}	F_{2AMax}	N	140000										
		lb _f	31500										
Max. tilting moment	M_{2KMax}	Nm	58000			71400							
		in.lb	513346			631947							
Efficiency at full load	η	%	95			93							
Service life	L_h	h	> 20000										
Weight (incl. standard adapter plate)	m	kg	350			380							
		lb _m	774			840							
Operating noise (at reference ratio and reference speed – ratio-specific values available in cymex [®])	L_{PA}	dB(A)	≤ 70			≤ 68							
		°C	+90										
Max. permitted housing temperature		F	194										
		°C	0 to +40										
Ambient temperature		F	32 to 104										
			Lubricated for life										
Lubrication			Lubricated for life										
Direction of rotation			In- and output same direction										
Protection class			IP 65										
Metal bellows coupling (recommended product type – validate sizing with cymex [®])			-										
Bore diameter of coupling on the application side		mm	-										
Mass moment of inertia (relates to the drive) Clamping hub diameter [mm] Optimized mass inertia version available on request	M	48	J_1	kgcm ²	-	-	85	55	43	48	34	29	28
				10 ⁻³ in.lb.s ²	-	-	75	49	38	42	30	26	25
	O	60	J_1	kgcm ²	230	174	-	-	-	-	-	-	-
				10 ⁻³ in.lb.s ²	204	154	-	-	-	-	-	-	-

Please use our sizing software cymex[®] for a detailed sizing – www.wittenstein-cymex.com

^{a)} At max. 10 % M_{2KMax}

^{b)} Valid for standard clamping hub diameter

^{c)} Refers to center of the output shaft or flange

^{d)} Please reduce input speed at higher ambient temperatures

View A

View B

2-stage

up to 60⁴⁾ (O)⁵⁾
clamping hub
diameter

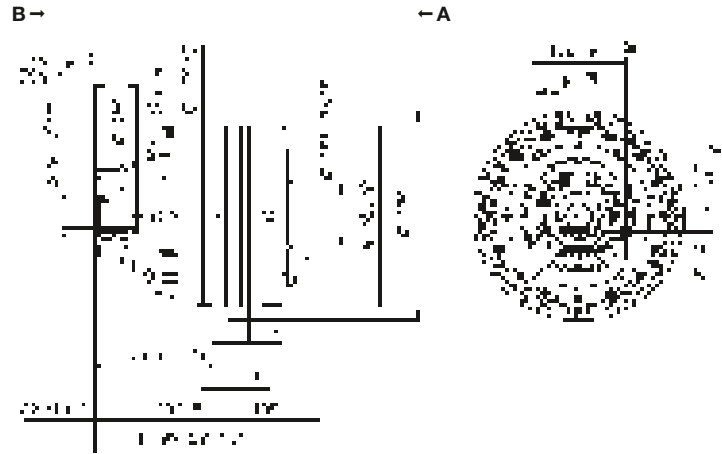
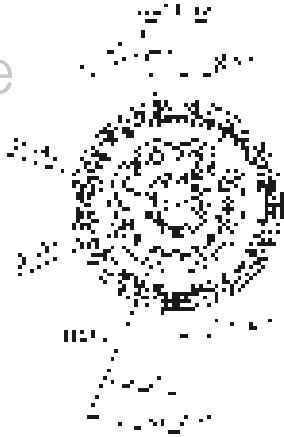

3-stage

up to 48⁴⁾ (M)⁵⁾
clamping hub
diameter

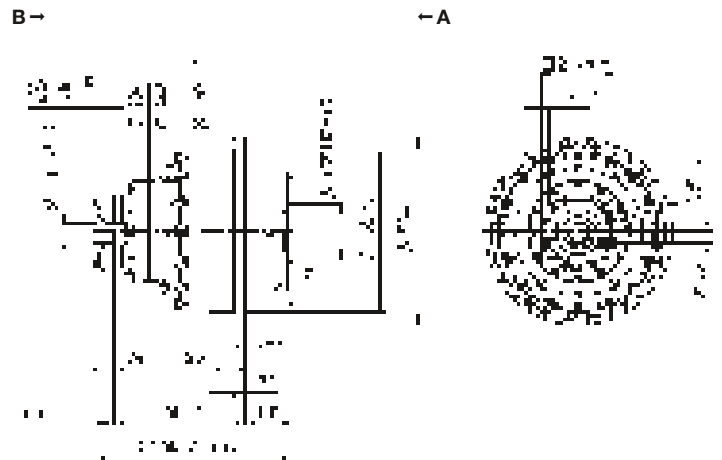
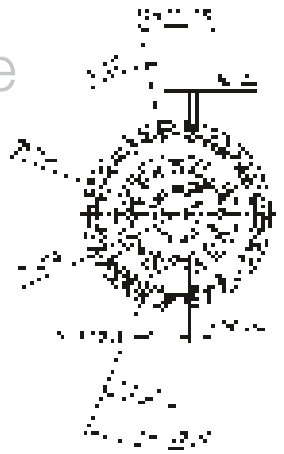

Motor shaft diameter [mm]

Planetary gearboxes

TP+

MA



Non-tolerated dimensions are nominal dimensions

¹⁾ Check motor shaft fit

²⁾ Min./Max. permissible motor shaft length. Longer motor shafts are possible, please contact alpha.

³⁾ The dimensions depend on the motor

⁴⁾ Smaller motor shaft diameter is compensated by a bushing with a minimum thickness of 1 mm

⁵⁾ Standard clamping hub diameter