

SP+ / SP+ HIGH SPEED – The classic all-rounder



SP+

The standard version of these low-backlash planetary gearboxes with output shaft is ideally suited for high positioning accuracy and highly dynamic cyclic operation. The SP+ HIGH SPEED is particularly appropriate for applications with maximum speeds during continuous operation.

Product highlights

Max. torsional backlash [arcmin] $\leq 1 - 4$

Various output configurations

Smooth shaft, shaft with key, splined shaft (DIN 5480), blind hollow shaft

High nominal speeds

SP+ HIGH SPEED version for applications in continuous operation

Flexible drive options

Clamping hub socket, coupling, optimized mass inertia, keyed clamping hub socket

Other gearbox models

Corrosion resistant design, ATEX, food-grade lubrication, low friction version

The SP+ compared to the industry standard

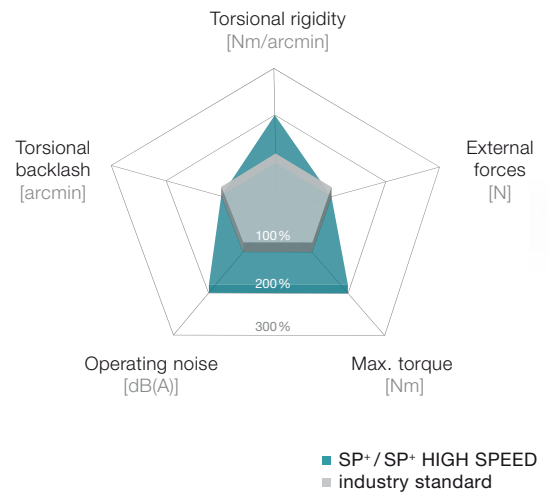

SP+ planetary gearbox in corrosion resistant design

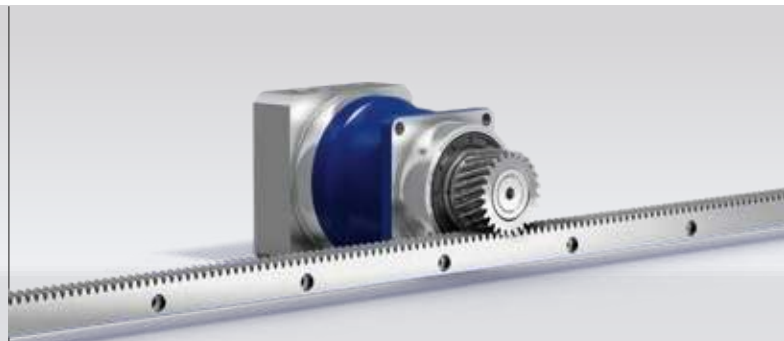

SP+ with rack and pinion

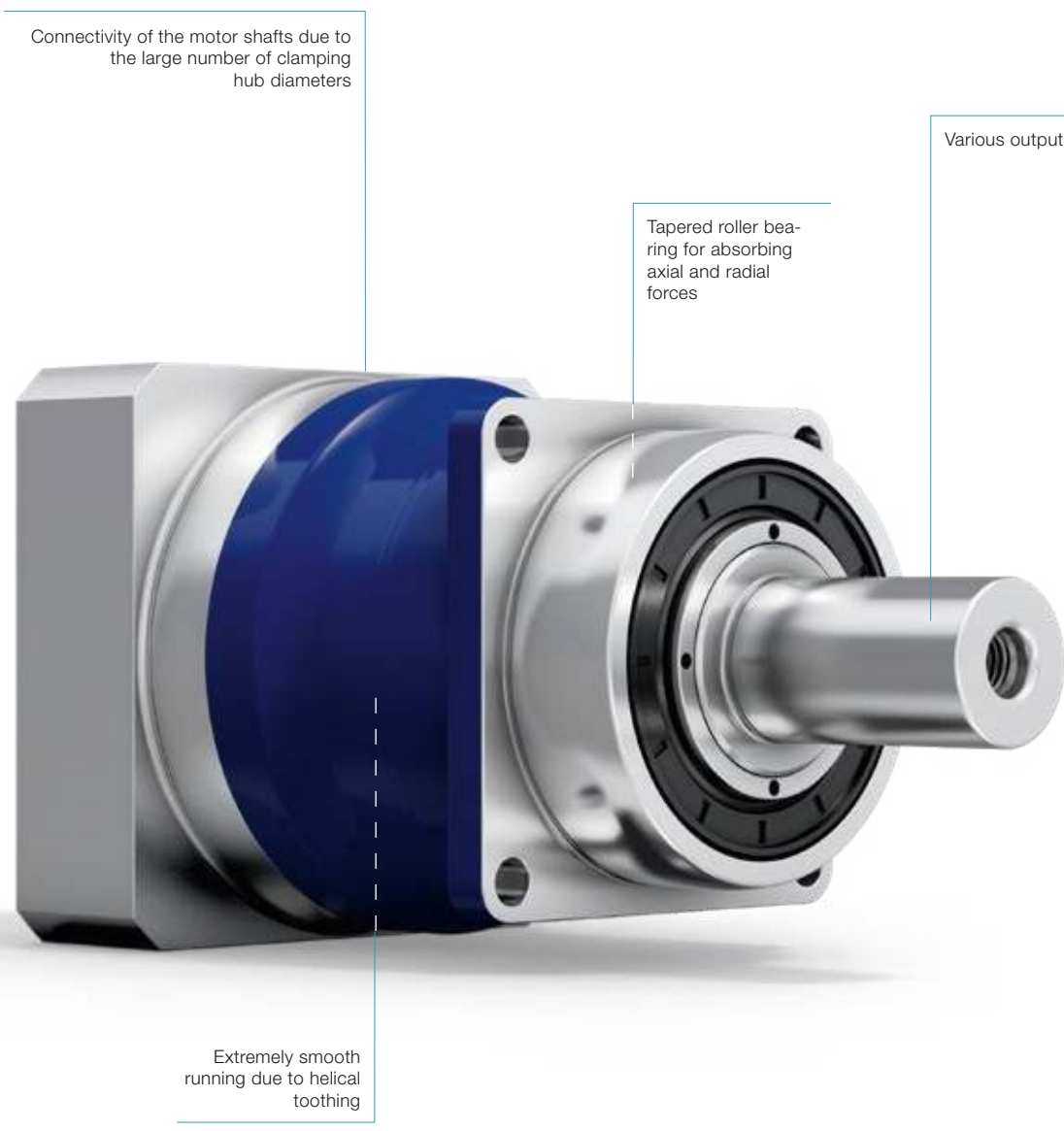

Connectivity of the motor shafts due to the large number of clamping hub diameters

Various output configurations

Tapered roller bearing for absorbing axial and radial forces

Extremely smooth running due to helical toothing

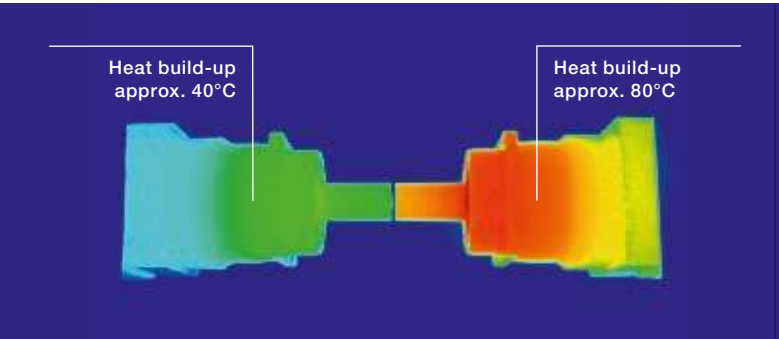

Heat build-up approx. 40°C

Heat build-up approx. 80°C

SP* HIGH SPEED MC version

Industry standard



SP* with metal bellows coupling

SP+ 060 MF 1-stage

			1-stage							
Ratio	<i>i</i>		3	4	5	7	8	10		
Max. torque ^{a) b) e)}	T_{2a}	Nm	48	67	67	67	51	51		
		in.lb	425	595	595	595	453	453		
Max. acceleration torque ^{b) e)} (max. 1000 cycles per hour)	T_{2B}	Nm	36	50	50	50	38	38		
		in.lb	319	443	443	443	336	336		
Nominal torque (at n_n)	T_{2N}	Nm	21	27	27	26	26	27		
		in.lb	190	239	236	226	230	237		
Emergency stop torque ^{a) b) e)} (permitted 1000 times during the service life of the gearbox)	T_{2Not}	Nm	96	109	109	109	100	100		
		in.lb	850	965	965	965	885	885		
Permitted average input speed (at T_{2a} and 20 °C ambient temperature) ^{d)}	n_{1N}	rpm	3300	3300	3300	4000	4000	4000		
Max. input speed	n_{1Max}	rpm	7500	7500	7500	7500	7500	7500		
Mean no load running torque ^{b)} (at $n_i = 3000$ rpm and 20 °C gearbox temperature)	T_{012}	Nm	0.68	0.52	0.48	0.34	0.32	0.32		
		in.lb	6.0	4.6	4.2	3.0	2.8	2.8		
Max. backlash	j_t	arcmin	Standard ≤ 4 / Reduced ≤ 2							
Torsional rigidity ^{b)}	C_{121}	Nm/arcmin	3.5							
		in.lb/arcmin	31							
Max. axial force ^{c)}	F_{2AMax}	N	2400							
		lb _f	540							
Max. lateral force ^{c)}	F_{2QMax}	N	2800							
		lb _f	630							
Max. tilting moment	M_{2KMax}	Nm	152							
		in.lb	1345							
Efficiency at full load	η	%	97							
Service life	L_h	h	> 20000							
Weight (incl. standard adapter plate)	m	kg	1.9							
		lb _m	4.2							
Operating noise (at reference ratio and reference speed – ratio-specific values available in cymex [®])	L_{pA}	dB(A)	≤ 58							
Max. permitted housing temperature		°C	+90							
		F	194							
Ambient temperature		°C	-15 to +40							
		F	5 to 104							
Lubrication			Lubricated for life							
Direction of rotation			In- and output same direction							
Protection class			IP 65							
Metal bellows coupling (recommended product type – validate sizing with cymex [®])			BC2-00060AA016.000-X							
Bore diameter of coupling on the application side		mm	X = 012.000 - 035.000							
Mass moment of inertia (relates to the drive) Clamping hub diameter [mm] Optimized mass inertia version available on request	B	11	J_i	kgcm ²	0.21	0.15	0.12	0.10	0.10	0.09
				10 ⁻³ in.lb.s ²	0.19	0.13	0.11	0.09	0.09	0.08
	C	14	J_i	kgcm ²	0.28	0.22	0.20	0.18	0.16	0.16
				10 ⁻³ in.lb.s ²	0.25	0.19	0.18	0.16	0.14	0.14
	E	19	J_i	kgcm ²	0.61	0.55	0.52	0.50	0.49	0.49
				10 ⁻³ in.lb.s ²	0.54	0.49	0.46	0.44	0.43	0.43

Please use our sizing software cymex[®] for a detailed sizing – www.wittenstein-cymex.com

^{a)} At max. 10 % F_{2QMax}

^{b)} Valid for standard clamping hub diameter

^{c)} Refers to center of the output shaft or flange

^{d)} Please reduce input speed at higher ambient temperatures

^{e)} Smooth shaft

View A

View B

1-stage

up to 11⁴⁾ (B)
clamping hub diameter

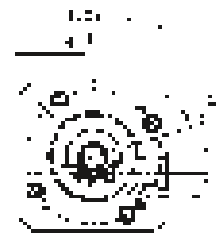
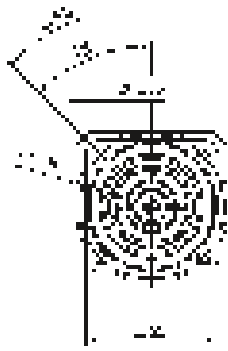

up to 14⁴⁾ (C)⁵⁾
clamping hub diameter

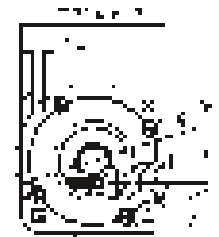
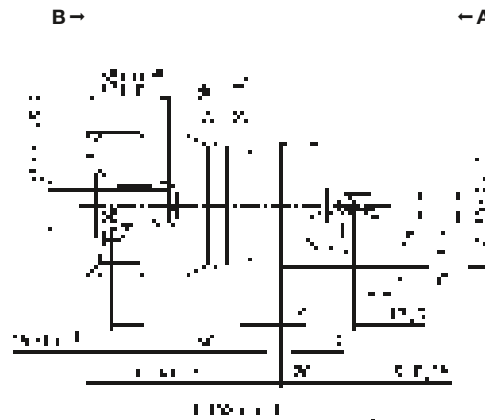
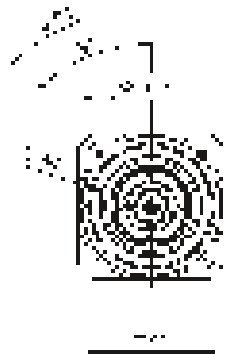

up to 19⁴⁾ (E)
clamping hub diameter

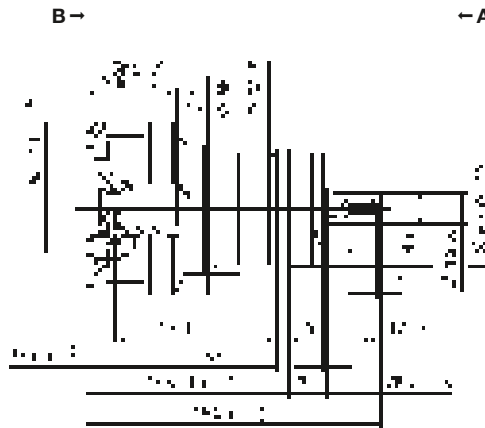
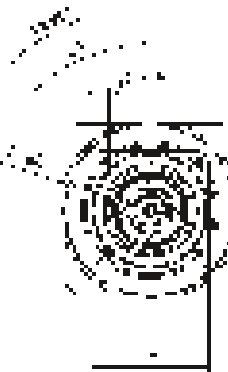

Motor shaft diameter [mm]

Other output variants

Shaft with key



Splined shaft (DIN 5480)

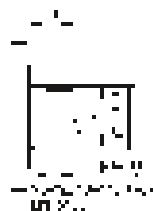

Shaft mounted

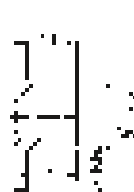

Non-tolerated dimensions are nominal dimensions

¹⁾ Check motor shaft fit

²⁾ Min./Max. permissible motor shaft length. Longer motor shafts are possible, please contact alpha.

³⁾ The dimensions depend on the motor

⁴⁾ Smaller motor shaft diameter is compensated by a bushing with a minimum thickness of 1 mm

⁵⁾ Standard clamping hub diameter

SP+ 060 MF 2-stage

			2-stage												
Ratio	<i>i</i>		16	20	25	28	32	35	40	50	64	70	100		
Max. torque ^{a) b) e)}	T_{2a}	Nm	57	57	67	57	57	67	57	67	48	56	48		
		in.lb	507	507	595	507	507	595	507	595	423	499	423		
Max. acceleration torque ^{b) e)} (max. 1000 cycles per hour)	T_{2B}	Nm	50	50	50	50	50	50	50	50	38	50	38		
		in.lb	443	443	443	443	443	443	443	443	336	443	336		
Nominal torque (at n_n)	T_{2N}	Nm	38	40	40	40	38	40	40	40	31	40	31		
		in.lb	332	354	351	357	333	357	357	357	270	357	272		
Emergency stop torque ^{a) b) e)} (permitted 1000 times during the service life of the gearbox)	T_{2Not}	Nm	109	109	109	109	109	109	109	109	109	109	100		
		in.lb	965	965	965	965	965	965	965	965	965	965	885		
Permitted average input speed (at T_{2a} and 20 °C ambient temperature) ^{d)}	n_{1N}	rpm	4400	4400	4400	4400	4400	4400	4400	4800	4800	5500	5500		
Max. input speed	n_{1Max}	rpm	8500	8500	8500	8500	8500	8500	8500	8500	8500	8500	8500		
Mean no load running torque ^{b)} (at $n_i = 3000$ rpm and 20 °C gearbox temperature)	T_{012}	Nm	0.28	0.25	0.23	0.22	0.24	0.20	0.20	0.19	0.19	0.17	0.18		
		in.lb	2.5	2.2	2.0	1.9	2.1	1.8	1.8	1.7	1.7	1.5	1.6		
Max. backlash	j_t	arcmin	Standard ≤ 6 / Reduced ≤ 4												
Torsional rigidity ^{b)}	C_{121}	Nm/arcmin	3.5												
		in.lb/arcmin	31												
Max. axial force ^{c)}	F_{2AMax}	N	2400												
		lb _f	540												
Max. lateral force ^{c)}	F_{2QMax}	N	2800												
		lb _f	630												
Max. tilting moment	M_{2KMax}	Nm	152												
		in.lb	1345												
Efficiency at full load	η	%	94												
Service life	L_h	h	> 20000												
Weight (incl. standard adapter plate)	m	kg	2.0												
		lb _m	4.4												
Operating noise (at reference ratio and reference speed – ratio-specific values available in cymex [®])	L_{pA}	dB(A)	≤ 57												
Max. permitted housing temperature		°C	+90												
		F	194												
Ambient temperature		°C	-15 to +40												
		F	5 to 104												
Lubrication			Lubricated for life												
Direction of rotation			In- and output same direction												
Protection class			IP 65												
Metal bellows coupling (recommended product type – validate sizing with cymex [®])			BC2-00060AA016.000-X												
Bore diameter of coupling on the application side		mm	X = 012.000 - 035.000												
Mass moment of inertia (relates to the drive) Clamping hub diameter [mm] Optimized mass inertia version available on request	B	11	J_i	kgcm ²	0.077	0.069	0.068	0.061	0.061	0.061	0.057	0.057	0.056	0.056	0.056
				10 ⁻³ in.lb.s ²	0.068	0.061	0.060	0.054	0.054	0.054	0.050	0.050	0.050	0.050	0.050
	C	14	J_i	kgcm ²	0.17	0.16	0.16	0.16	0.16	0.16	0.15	0.15	0.15	0.15	0.15
				10 ⁻³ in.lb.s ²	0.15	0.14	0.14	0.14	0.14	0.14	0.13	0.13	0.13	0.13	0.13

Please use our sizing software cymex[®] for a detailed sizing – www.wittenstein-cymex.com

^{a)} At max. 10 % F_{2QMax}

^{b)} Valid for standard clamping hub diameter

^{c)} Refers to center of the output shaft or flange

^{d)} Please reduce input speed at higher ambient temperatures

^{e)} Smooth shaft

View A

View B

2-stage

up to 11⁴⁾ (B)⁵⁾
clamping hub diameter

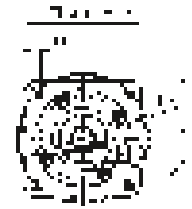
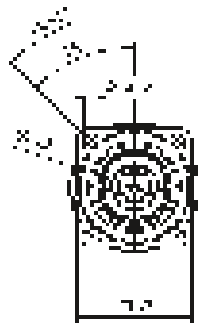

Motor shaft diameter [mm]

up to 14⁴⁾ (C)
clamping hub diameter

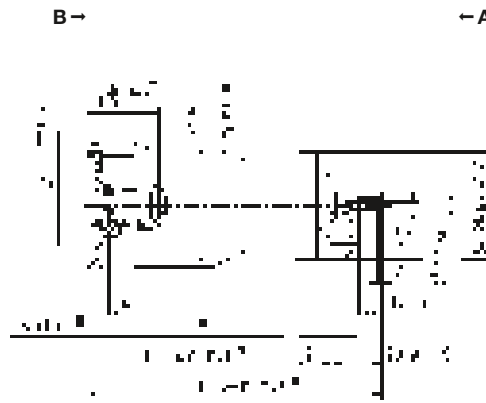

Planetary gearboxes

SP+

MF

Other output variants

Shaft with key



Splined shaft (DIN 5480)

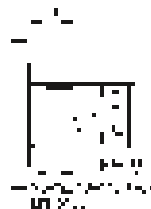

Shaft mounted



Non-tolerated dimensions are nominal dimensions

¹⁾ Check motor shaft fit

²⁾ Min./Max. permissible motor shaft length. Longer motor shafts are possible, please contact alpha.

³⁾ The dimensions depend on the motor

⁴⁾ Smaller motor shaft diameter is compensated by a bushing with a minimum thickness of 1 mm

⁵⁾ Standard clamping hub diameter

SP+ 075 MF 1-stage

			1-stage							
Ratio	<i>i</i>		3	4	5	7	8	10		
Max. torque ^{a) b) e)}	T_{2a}	Nm	136	176	176	176	152	152		
		in.lb	1204	1558	1558	1558	1345	1345		
Max. acceleration torque ^{b) e)} (max. 1000 cycles per hour)	T_{2B}	Nm	102	132	132	132	114	114		
		in.lb	903	1168	1168	1168	1009	1009		
Nominal torque (at n_n)	T_{2N}	Nm	63	81	81	81	80	81		
		in.lb	558	719	716	719	712	720		
Emergency stop torque ^{a) b) e)} (permitted 1000 times during the service life of the gearbox)	T_{2Not}	Nm	139	185	250	250	250	250		
		in.lb	1230	1640	2213	2213	2213	2213		
Permitted average input speed (at T_{2a} and 20 °C ambient temperature) ^{d)}	n_{1N}	rpm	2900	2900	2900	3100	3100	3100		
Max. input speed	n_{1Max}	rpm	7500	7500	7500	7500	7500	7500		
Mean no load running torque ^{b)} (at $n_i = 3000$ rpm and 20 °C gearbox temperature)	T_{012}	Nm	1.5	1.4	0.96	0.72	0.55	0.52		
		in.lb	14	12	8.5	6.4	4.9	4.6		
Max. backlash	j_t	arcmin	Standard ≤ 4 / Reduced ≤ 2							
Torsional rigidity ^{b)}	C_{121}	Nm/arcmin	10							
		in.lb/arcmin	89							
Max. axial force ^{c)}	F_{2AMax}	N	3350							
		lb _f	754							
Max. lateral force ^{c)}	F_{2QMax}	N	4200							
		lb _f	945							
Max. tilting moment	M_{2KMax}	Nm	236							
		in.lb	2089							
Efficiency at full load	η	%	97							
Service life	L_h	h	> 20000							
Weight (incl. standard adapter plate)	m	kg	3.9							
		lb _m	8.6							
Operating noise (at reference ratio and reference speed – ratio-specific values available in cymex [®])	L_{pA}	dB(A)	≤ 59							
Max. permitted housing temperature		°C	+90							
		F	194							
Ambient temperature		°C	-15 to +40							
		F	5 to 104							
Lubrication			Lubricated for life							
Direction of rotation			In- and output same direction							
Protection class			IP 65							
Metal bellows coupling (recommended product type – validate sizing with cymex [®])			BC2-00150AA022.000-X							
Bore diameter of coupling on the application side		mm	X = 019.000 - 042.000							
Mass moment of inertia (relates to the drive) Clamping hub diameter [mm] Optimized mass inertia version available on request	C	14	J_i	kgcm ²	0.86	0.61	0.51	0.42	0.38	0.38
				10 ⁻³ in.lb.s ²	0.76	0.54	0.45	0.37	0.34	0.34
	E	19	J_i	kgcm ²	1.03	0.78	0.68	0.59	0.54	0.54
				10 ⁻³ in.lb.s ²	0.91	0.69	0.60	0.52	0.48	0.48
	G	24	J_i	kgcm ²	2.40	2.15	2.05	1.96	1.91	1.91
				10 ⁻³ in.lb.s ²	2.12	1.90	1.81	1.73	1.69	1.69

Please use our sizing software cymex[®] for a detailed sizing – www.wittenstein-cymex.com

- ^{a)} At max. 10 % F_{2QMax}
- ^{b)} Valid for standard clamping hub diameter
- ^{c)} Refers to center of the output shaft or flange
- ^{d)} Please reduce input speed at higher ambient temperatures
- ^{e)} Smooth shaft

View A

View B

1-stage

up to 14⁴⁾ (C)
clamping hub diameter

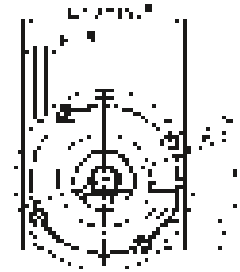
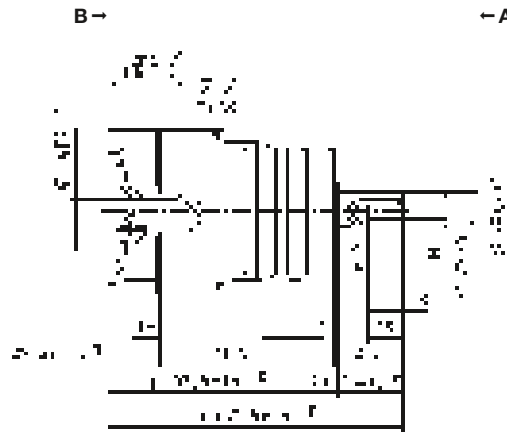
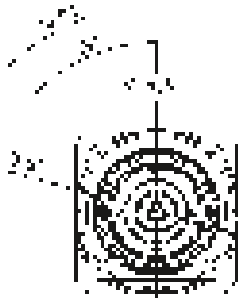

up to 19⁴⁾ (E)⁵⁾
clamping hub diameter

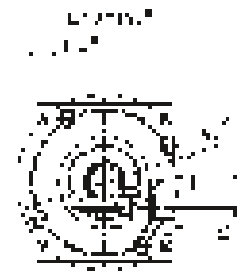
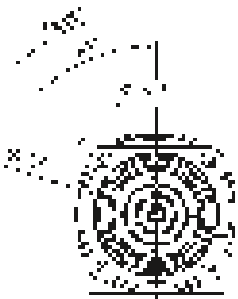

up to 24⁴⁾ (G)
clamping hub diameter

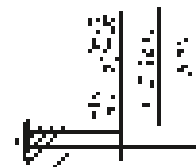
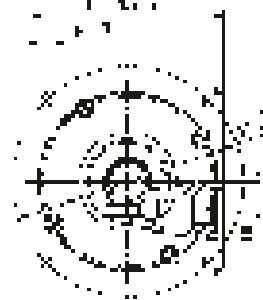
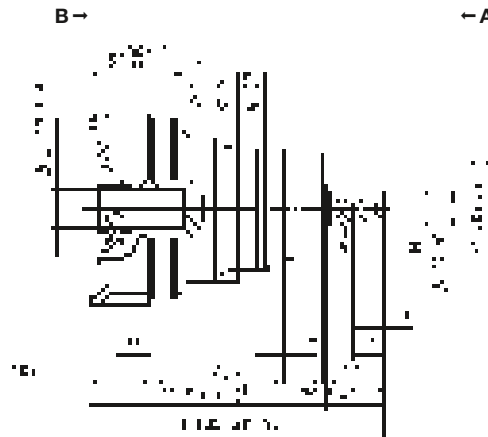
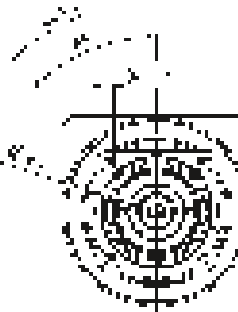

Motor shaft diameter [mm]

Other output variants

Shaft with key

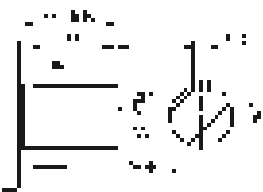

Splined shaft (DIN 5480)



Shaft mounted

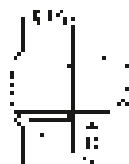

Non-tolerated dimensions are nominal dimensions

¹⁾ Check motor shaft fit

²⁾ Min./Max. permissible motor shaft length. Longer motor shafts are possible, please contact alpha.

³⁾ The dimensions depend on the motor

⁴⁾ Smaller motor shaft diameter is compensated by a bushing with a minimum thickness of 1 mm

⁵⁾ Standard clamping hub diameter

SP+ 075 MF 2-stage

			2-stage											
Ratio	i		16	20	25	28	32	35	40	50	64	70	100	
Max. torque ^{a) b) e)}	T_{2a}	Nm	126	126	158	126	126	158	126	158	105	113	105	
		in.lb	1118	1118	1398	1118	1118	1398	1118	1398	932	998	932	
Max. acceleration torque ^{b) e)} (max. 1000 cycles per hour)	T_{2B}	Nm	126	126	132	126	126	132	126	132	105	113	105	
		in.lb	1118	1118	1168	1118	1118	1168	1118	1168	932	998	932	
Nominal torque (at n_n)	T_{2N}	Nm	101	101	106	101	101	106	101	106	84	90	84	
		in.lb	895	895	935	895	895	935	895	935	746	799	746	
Emergency stop torque ^{a) b) e)} (permitted 1000 times during the service life of the gearbox)	T_{2Not}	Nm	250	250	250	250	250	250	250	250	250	250	250	
		in.lb	2213	2213	2213	2213	2213	2213	2213	2213	2213	2213	2213	
Permitted average input speed (at T_{2a} and 20 °C ambient temperature) ^{d)}	n_{1N}	rpm	3500	3500	3500	3500	3500	3500	3500	3800	3800	4500	4500	
Max. input speed	n_{1Max}	rpm	8500	8500	8500	8500	8500	8500	8500	8500	8500	8500	8500	
Mean no load running torque ^{b)} (at $n_i = 3000$ rpm and 20 °C gearbox temperature)	T_{012}	Nm	0.50	0.41	0.35	0.32	0.44	0.28	0.26	0.23	0.23	0.21	0.23	
		in.lb	4.4	3.6	3.1	2.8	3.9	2.5	2.3	2.0	2.0	1.9	2.0	
Max. backlash	j_t	arcmin	Standard ≤ 6 / Reduced ≤ 4											
Torsional rigidity ^{b)}	C_{121}	Nm/arcmin	10											
		in.lb/arcmin	89											
Max. axial force ^{c)}	F_{2AMax}	N	3350											
		lb _f	754											
Max. lateral force ^{c)}	F_{2QMax}	N	4200											
		lb _f	945											
Max. tilting moment	M_{2KMax}	Nm	236											
		in.lb	2089											
Efficiency at full load	η	%	94											
Service life	L_h	h	> 20000											
Weight (incl. standard adapter plate)	m	kg	3.6											
		lb _m	8.0											
Operating noise (at reference ratio and reference speed – ratio-specific values available in cymex [®])	L_{pA}	dB(A)	≤ 55											
Max. permitted housing temperature		°C	+90											
		F	194											
Ambient temperature		°C	-15 to +40											
		F	5 to 104											
Lubrication			Lubricated for life											
Direction of rotation			In- and output same direction											
Protection class			IP 65											
Metal bellows coupling (recommended product type – validate sizing with cymex [®])			BC2-00150AA022.000-X											
Bore diameter of coupling on the application side		mm	X = 019.000 - 042.000											
Mass moment of inertia (relates to the drive) Clamping hub diameter [mm] Optimized mass inertia version available on request	B	11	J_i	kgcm ²	0.16	0.13	0.13	0.10	0.10	0.10	0.09	0.09	0.09	0.09
				10 ⁻³ in.lb.s ²	0.14	0.12	0.12	0.09	0.09	0.09	0.08	0.08	0.08	0.08
	C	14	J_i	kgcm ²	0.23	0.20	0.20	0.18	0.18	0.18	0.16	0.16	0.16	0.16
				10 ⁻³ in.lb.s ²	0.20	0.18	0.18	0.16	0.16	0.16	0.14	0.14	0.14	0.14
	E	19	J_i	kgcm ²	0.55	0.53	0.52	0.50	0.50	0.50	0.49	0.49	0.49	0.49
				10 ⁻³ in.lb.s ²	0.49	0.47	0.46	0.44	0.44	0.44	0.43	0.43	0.43	0.43

Please use our sizing software cymex[®] for a detailed sizing – www.wittenstein-cymex.com

- ^{a)} At max. 10 % F_{2QMax}
- ^{b)} Valid for standard clamping hub diameter
- ^{c)} Refers to center of the output shaft or flange
- ^{d)} Please reduce input speed at higher ambient temperatures
- ^{e)} Smooth shaft

2-stage

up to 11⁴⁾ (B)
clamping hub diameter

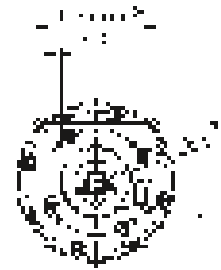
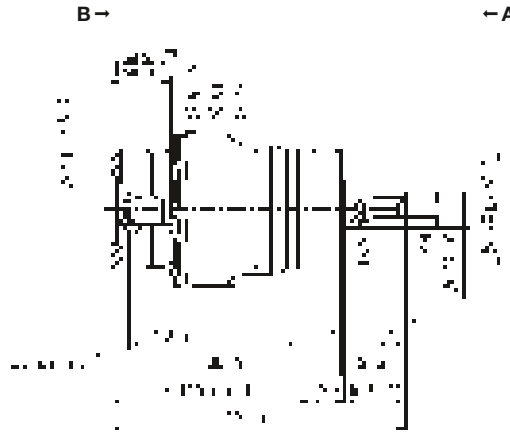
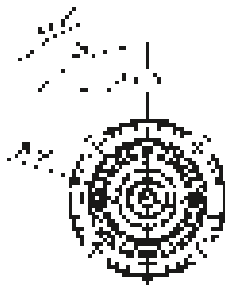

up to 14⁴⁾ (C)⁵⁾
clamping hub diameter

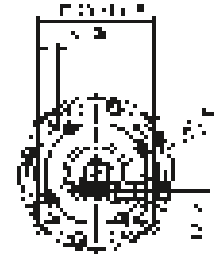
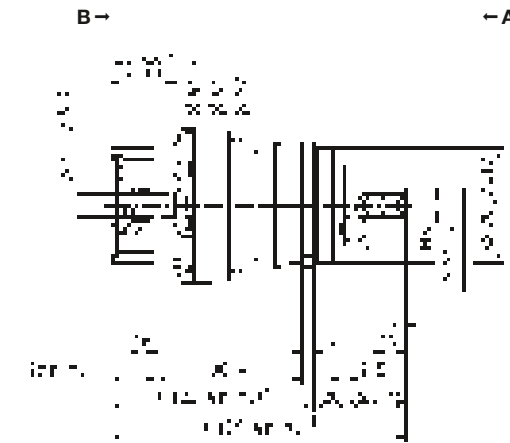
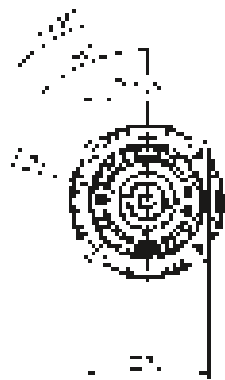

up to 19⁴⁾ (E)
clamping hub diameter

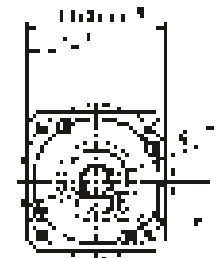
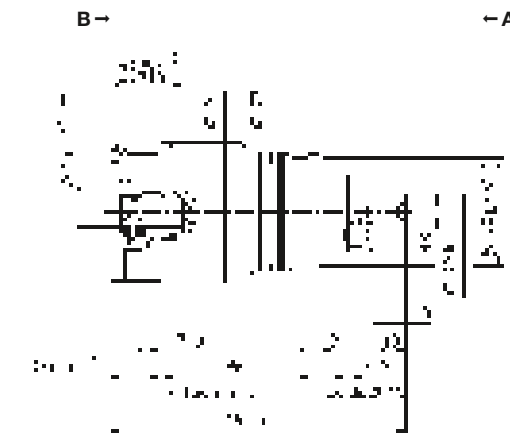
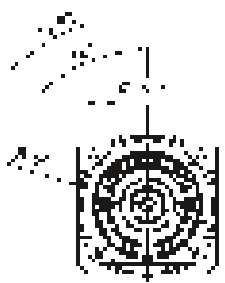

Motor shaft diameter [mm]

Other output variants

Shaft with key

Splined shaft (DIN 5480)

Shaft mounted

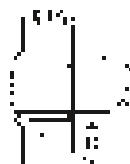
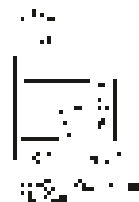

Non-tolerated dimensions are nominal dimensions

¹⁾ Check motor shaft fit

²⁾ Min./Max. permissible motor shaft length. Longer motor shafts are possible, please contact alpha.

³⁾ The dimensions depend on the motor

⁴⁾ Smaller motor shaft diameter is compensated by a bushing with a minimum thickness of 1 mm

⁵⁾ Standard clamping hub diameter

SP+ 100 MF 1-stage

			1-stage							
Ratio	<i>i</i>		3	4	5	7	8	10		
Max. torque ^{a) b) e)}	T_{2a}	Nm	376	495	495	428	376	376		
		in.lb	3328	4381	4381	3784	3328	3328		
Max. acceleration torque ^{b) e)} (max. 1000 cycles per hour)	T_{2B}	Nm	282	378	378	378	282	282		
		in.lb	2496	3346	3346	3346	2496	2496		
Nominal torque (at n_N)	T_{2N}	Nm	131	171	169	166	166	174		
		in.lb	1157	1510	1498	1473	1470	1538		
Emergency stop torque ^{a) b) e)} (permitted 1000 times during the service life of the gearbox)	T_{2Not}	Nm	500	625	625	625	625	625		
		in.lb	4425	5532	5532	5532	5532	5532		
Permitted average input speed (at T_{2a} and 20 °C ambient temperature) ^{d)}	n_{1N}	rpm	2500	2500	2500	2800	2800	2800		
Max. input speed	n_{1Max}	rpm	5500	5500	5500	5500	5500	5500		
Mean no load running torque ^{b)} (at $n_i = 3000$ rpm and 20 °C gearbox temperature)	T_{012}	Nm	3.1	2.4	2.1	1.3	1.0	1.0		
		in.lb	28	21	18	12	9.2	9.2		
Max. backlash	j_t	arcmin	Standard ≤ 3 / Reduced ≤ 1							
Torsional rigidity ^{b)}	C_{121}	Nm/arcmin	31							
		in.lb/arcmin	274							
Max. axial force ^{c)}	F_{2AMax}	N	5650							
		lb _f	1271							
Max. lateral force ^{c)}	F_{2QMax}	N	6600							
		lb _f	1485							
Max. tilting moment	M_{2KMax}	Nm	487							
		in.lb	4310							
Efficiency at full load	η	%	97							
Service life	L_h	h	> 20000							
Weight (incl. standard adapter plate)	m	kg	7.7							
		lb _m	17							
Operating noise (at reference ratio and reference speed – ratio-specific values available in cymex [®])	L_{pA}	dB(A)	≤ 58							
			+90							
Max. permitted housing temperature		°C	+90							
		F	194							
Ambient temperature		°C	-15 to +40							
		F	5 to 104							
Lubrication			Lubricated for life							
Direction of rotation			In- and output same direction							
Protection class			IP 65							
Metal bellows coupling (recommended product type – validate sizing with cymex [®])			BC2-00300AA032.000-X							
	Bore diameter of coupling on the application side	mm	X = 024.000 - 060.000							
Mass moment of inertia (relates to the drive) Clamping hub diameter [mm] Optimized mass inertia version available on request	E	19	J_i	kgcm ²	3.29	2.35	1.92	1.60	1.38	1.38
				10 ⁻³ in.lb.s ²	2.91	2.08	1.70	1.42	1.22	1.22
	G	24	J_i	kgcm ²	3.99	3.04	2.61	2.29	2.07	2.07
				10 ⁻³ in.lb.s ²	3.53	2.69	2.31	2.03	1.83	1.83
	H	28	J_i	kgcm ²	3.59	2.65	2.22	1.90	1.68	1.68
				10 ⁻³ in.lb.s ²	3.18	2.35	1.96	1.68	1.49	1.49
	K	38	J_i	kgcm ²	11.1	10.1	9.68	9.36	9.14	9.14
				10 ⁻³ in.lb.s ²	9.82	8.94	8.57	8.28	8.09	8.09

Please use our sizing software cymex[®] for a detailed sizing – www.wittenstein-cymex.com

^{a)} At max. 10 % F_{2QMax}

^{b)} Valid for standard clamping hub diameter

^{c)} Refers to center of the output shaft or flange

^{d)} Please reduce input speed at higher ambient temperatures

^{e)} Smooth shaft

View A

View B

1-stage

up to 19⁴⁾ (E)
clamping hub diameter

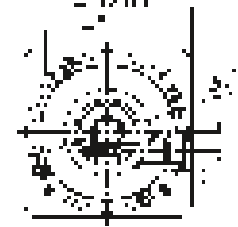
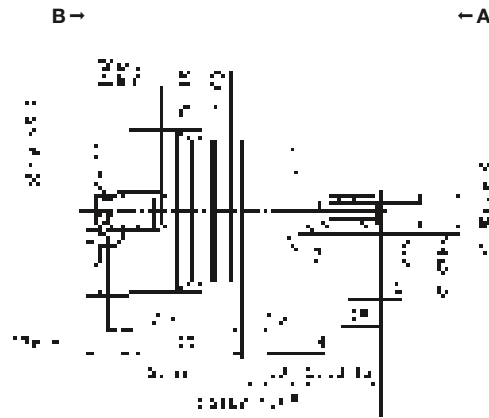
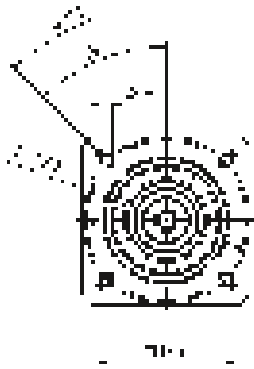

up to 24/28⁴⁾ (G⁵⁾/H)
clamping hub diameter

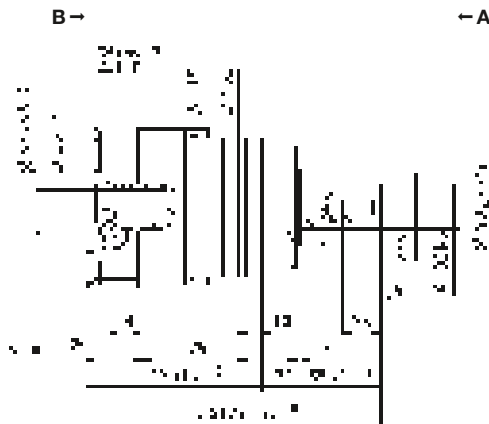
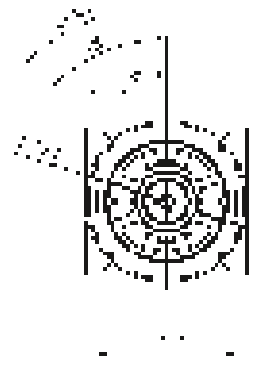

up to 38⁴⁾ (K)
clamping hub diameter

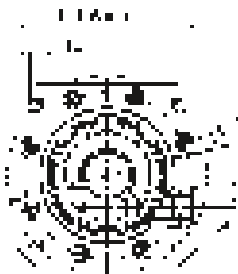
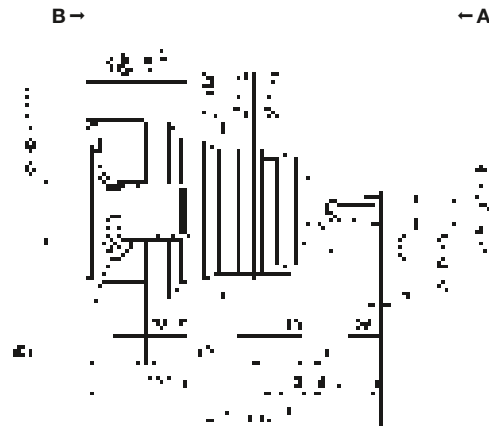
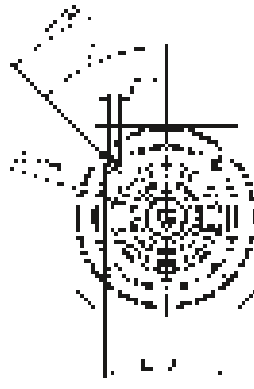

Motor shaft diameter [mm]

Other output variants

Shaft with key

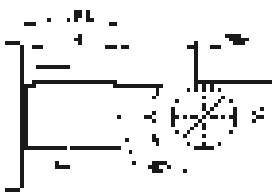

Splined shaft (DIN 5480)



Shaft mounted



Non-tolerated dimensions are nominal dimensions

¹⁾ Check motor shaft fit

²⁾ Min./Max. permissible motor shaft length. Longer motor shafts are possible, please contact alpha.

³⁾ The dimensions depend on the motor

⁴⁾ Smaller motor shaft diameter is compensated by a bushing with a minimum thickness of 1 mm

⁵⁾ Standard clamping hub diameter

SP+ 100 MF 2-stage

			2-stage												
Ratio	<i>i</i>		16	20	25	28	32	35	40	50	64	70	100		
Max. torque ^{a) b) e)}	T_{2a}	Nm	347	347	347	347	347	347	347	347	259	347	259		
		in.lb	3067	3067	3067	3067	3067	3067	3067	3067	3067	2288	3067	2288	
Max. acceleration torque ^{b) e)} (max. 1000 cycles per hour)	T_{2B}	Nm	347	347	347	347	347	347	347	347	259	347	259		
		in.lb	3067	3067	3067	3067	3067	3067	3067	3067	3067	2288	3067	2288	
Nominal torque (at n_{1N})	T_{2N}	Nm	243	259	257	277	243	277	277	277	207	277	207		
		in.lb	2146	2295	2277	2453	2153	2453	2453	2453	1830	2453	1830		
Emergency stop torque ^{a) b) e)} (permitted 1000 times during the service life of the gearbox)	T_{2Not}	Nm	625	625	625	625	625	625	625	625	625	625	625		
		in.lb	5532	5532	5532	5532	5532	5532	5532	5532	5532	5532	5532		
Permitted average input speed (at T_{2a} and 20 °C ambient temperature) ^{d)}	n_{1N}	rpm	3100	3100	3100	3100	3100	3100	3100	3500	3500	4200	4200		
Max. input speed	n_{1Max}	rpm	6500	6500	6500	6500	6500	6500	6500	6500	6500	6500	6500		
Mean no load running torque ^{b)} (at $n_1 = 3000$ rpm and 20 °C gearbox temperature)	T_{012}	Nm	1.0	0.93	0.85	0.77	0.86	0.54	0.54	0.46	0.46	0.39	0.37		
		in.lb	9.2	8.2	7.5	6.8	7.6	4.8	4.8	4.1	4.1	3.5	3.3		
Max. backlash	j_t	arcmin	Standard ≤ 5 / Reduced ≤ 3												
Torsional rigidity ^{b)}	C_{121}	Nm/arcmin	31												
		in.lb/arcmin	274												
Max. axial force ^{c)}	F_{2AMax}	N	5650												
		lb _f	1271												
Max. lateral force ^{c)}	F_{2QMax}	N	6600												
		lb _f	1485												
Max. tilting moment	M_{2KMax}	Nm	487												
		in.lb	4310												
Efficiency at full load	η	%	94												
Service life	L_h	h	> 20000												
Weight (incl. standard adapter plate)	m	kg	7.9												
		lb _m	17.5												
Operating noise (at reference ratio and reference speed – ratio-specific values available in cymex [®])	L_{pA}	dB(A)	≤ 56												
Max. permitted housing temperature		°C	+90												
		F	194												
Ambient temperature		°C	-15 to +40												
		F	5 to 104												
Lubrication			Lubricated for life												
Direction of rotation			In- and output same direction												
Protection class			IP 65												
Metal bellows coupling (recommended product type – validate sizing with cymex [®])			BC2-00300AA032.000-X												
Bore diameter of coupling on the application side		mm	X = 024.000 - 060.000												
Mass moment of inertia (relates to the drive) Clamping hub diameter [mm] Optimized mass inertia version available on request	C	14	J_1	kgcm ²	0.64	0.54	0.52	0.43	0.43	0.43	0.38	0.38	0.54	0.37	0.37
				10 ⁻³ in.lb.s ²	0.57	0.48	0.46	0.38	0.38	0.38	0.34	0.34	0.48	0.33	0.33
	E	19	J_1	kgcm ²	0.81	0.70	0.68	0.60	0.43	0.59	0.55	0.54	0.38	0.54	0.54
				10 ⁻³ in.lb.s ²	0.72	0.62	0.60	0.53	0.38	0.52	0.49	0.48	0.34	0.48	0.48
	G	24	J_1	kgcm ²	2.18	2.07	2.05	1.97	1.97	1.96	1.92	1.91	1.91	1.91	1.91
				10 ⁻³ in.lb.s ²	1.93	1.83	1.81	1.74	1.74	1.73	1.70	1.69	1.69	1.69	1.69
	H	28	J_1	kgcm ²	1.98	1.90	1.88	1.81	1.81	1.80	1.76	1.75	1.75	1.75	1.75
				10 ⁻³ in.lb.s ²	1.75	1.68	1.66	1.60	1.60	1.59	1.56	1.55	1.55	1.55	1.55

Please use our sizing software cymex[®] for a detailed sizing – www.wittenstein-cymex.com

- ^{a)} At max. 10 % F_{2QMax}
- ^{b)} Valid for standard clamping hub diameter
- ^{c)} Refers to center of the output shaft or flange
- ^{d)} Please reduce input speed at higher ambient temperatures
- ^{e)} Smooth shaft

View A

View B

2-stage

up to 14⁴⁾ (C) clamping hub diameter

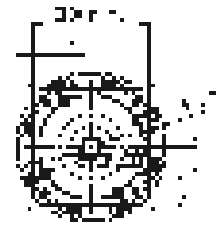
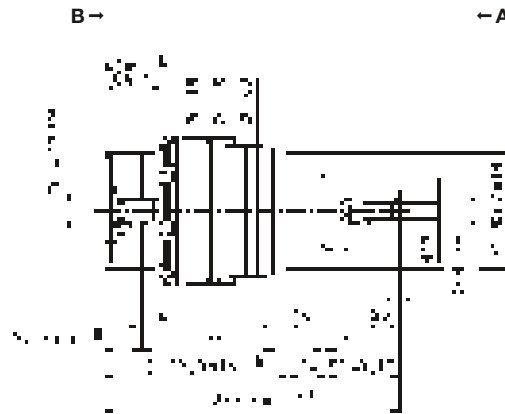
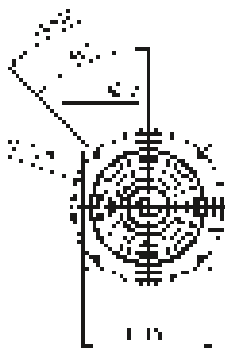

up to 19⁴⁾ (E)⁵⁾ clamping hub diameter

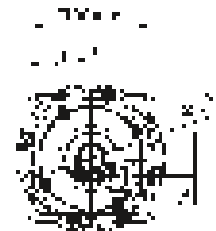
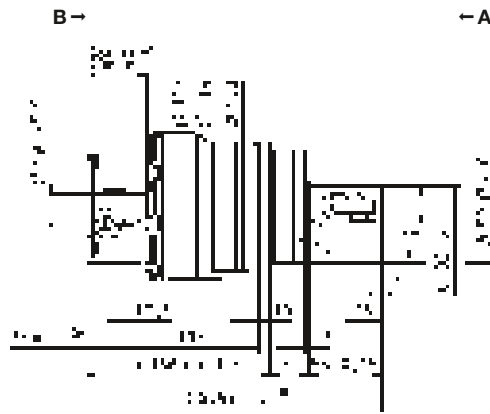
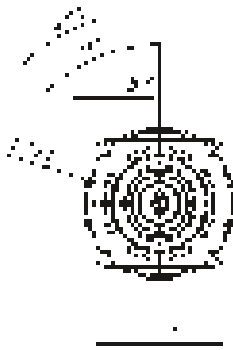

up to 24/28⁴⁾ (G/H) clamping hub diameter

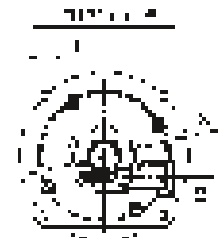
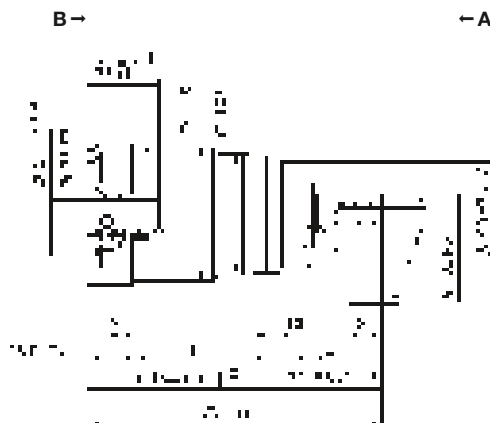
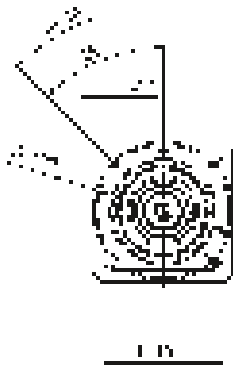

Motor shaft diameter [mm]

Other output variants

Shaft with key



Splined shaft (DIN 5480)



Shaft mounted

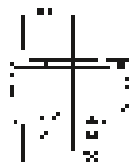

Non-tolerated dimensions are nominal dimensions

¹⁾ Check motor shaft fit

²⁾ Min./Max. permissible motor shaft length. Longer motor shafts are possible, please contact alpha.

³⁾ The dimensions depend on the motor

⁴⁾ Smaller motor shaft diameter is compensated by a bushing with a minimum thickness of 1 mm

⁵⁾ Standard clamping hub diameter

SP+ 140 MF 1-stage

			1-stage							
Ratio	<i>i</i>		3	4	5	7	8	10		
Max. torque ^{a) b) e)}	T_{2a}	Nm	624	1056	1056	825	720	720		
		in.lb	5523	9346	9346	7302	6373	6373		
Max. acceleration torque ^{b) e)} (max. 1000 cycles per hour)	T_{2B}	Nm	468	792	792	792	636	636		
		in.lb	4142	7010	7010	7010	5629	5629		
Nominal torque (at n_n)	T_{2N}	Nm	202	335	333	319	312	327		
		in.lb	1786	2962	2944	2820	2763	2894		
Emergency stop torque ^{a) b) e)} (permitted 1000 times during the service life of the gearbox)	T_{2Not}	Nm	1250	1350	1350	1350	1250	1250		
		in.lb	11064	11949	11949	11949	11064	11064		
Permitted average input speed (at T_{2a} and 20 °C ambient temperature) ^{d)}	n_{1N}	rpm	2100	2100	2100	2600	2600	2600		
Max. input speed	n_{1Max}	rpm	5000	5000	5000	5000	5000	5000		
Mean no load running torque ^{b)} (at $n_i = 3000$ rpm and 20 °C gearbox temperature)	T_{012}	Nm	6.7	5.4	4.4	2.8	2.5	2.2		
		in.lb	60	47	39	25	23	19		
Max. backlash	j_t	arcmin	Standard ≤ 3 / Reduced ≤ 1							
Torsional rigidity ^{b)}	C_{121}	Nm/arcmin	53							
		in.lb/arcmin	469							
Max. axial force ^{c)}	F_{2AMax}	N	9870							
		lb _f	2221							
Max. lateral force ^{c)}	F_{2QMax}	N	9900							
		lb _f	2228							
Max. tilting moment	M_{2KMax}	Nm	952							
		in.lb	8426							
Efficiency at full load	η	%	97							
Service life	L_h	h	> 20000							
Weight (incl. standard adapter plate)	m	kg	17.2							
		lb _m	38							
Operating noise (at reference ratio and reference speed – ratio-specific values available in cymex [®])	L_{pA}	dB(A)	≤ 59							
Max. permitted housing temperature		°C	+90							
		F	194							
Ambient temperature		°C	-15 to +40							
		F	5 to 104							
Lubrication			Lubricated for life							
Direction of rotation			In- and output same direction							
Protection class			IP 65							
Metal bellows coupling (recommended product type – validate sizing with cymex [®])			BC2-00800AA040.000-X							
Bore diameter of coupling on the application side		mm	X = 040.000 - 075.000							
Mass moment of inertia (relates to the drive) Clamping hub diameter [mm] Optimized mass inertia version available on request	G	24	J_i	kgcm ²	10.7	7.82	6.79	5.84	5.28	5.28
				10 ⁻³ in.lb.s ²	9.47	6.92	6.01	5.17	4.67	4.67
	I	32	J_i	kgcm ²	13.8	11.0	9.95	9.00	8.44	8.44
				10 ⁻³ in.lb.s ²	12.2	9.74	8.81	7.97	7.47	7.47
	K	38	J_i	kgcm ²	14.9	12.1	11.0	10.1	9.51	9.51
				10 ⁻³ in.lb.s ²	13.2	10.7	9.74	8.94	8.42	8.42
	M	48	J_i	kgcm ²	29.5	26.7	25.6	24.7	24.2	24.2
				10 ⁻³ in.lb.s ²	26.1	23.6	22.7	21.9	21.4	21.4

Please use our sizing software cymex[®] for a detailed sizing – www.wittenstein-cymex.com

^{a)} At max. 10 % F_{2QMax}

^{b)} Valid for standard clamping hub diameter

^{c)} Refers to center of the output shaft or flange

^{d)} Please reduce input speed at higher ambient temperatures

^{e)} Smooth shaft

View A

View B

1-stage

up to 24⁴⁾ (G)
clamping hub diameter

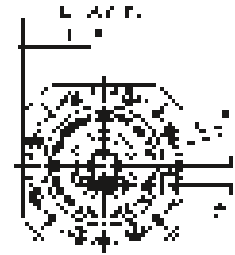
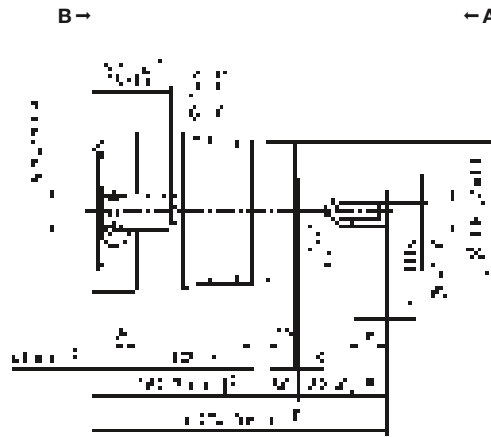
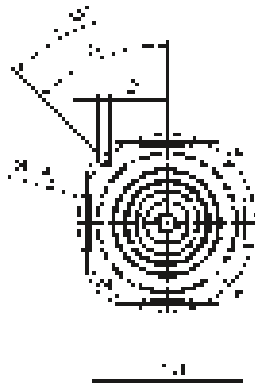

up to 32/38⁴⁾
(I/K⁵⁾ clamping hub diameter

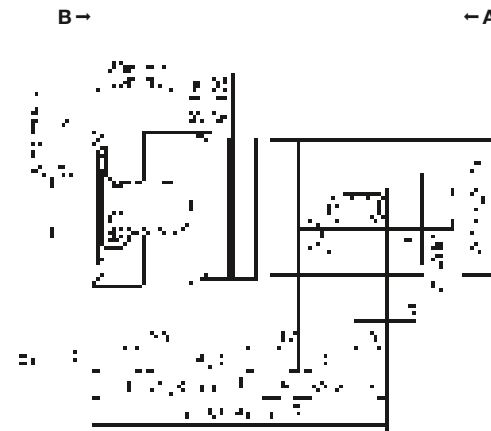

up to 48⁴⁾ (M)
clamping hub diameter

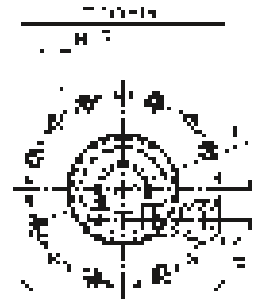
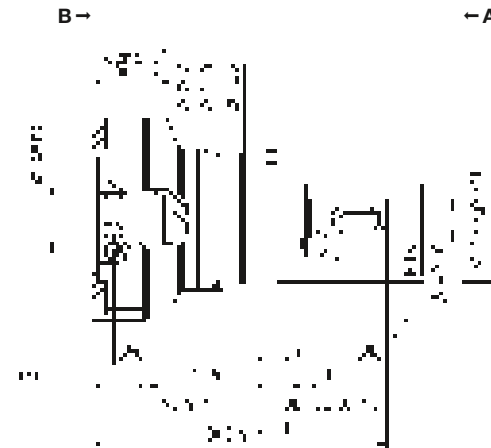
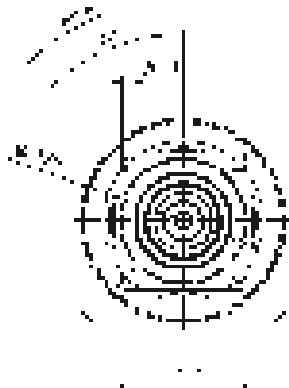

Motor shaft diameter [mm]

Other output variants

Shaft with key

Splined shaft (DIN 5480)

Shaft mounted

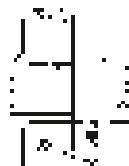
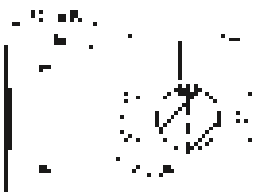

Non-tolerated dimensions are nominal dimensions

¹⁾ Check motor shaft fit

²⁾ Min./Max. permissible motor shaft length. Longer motor shafts are possible, please contact alpha.

³⁾ The dimensions depend on the motor

⁴⁾ Smaller motor shaft diameter is compensated by a bushing with a minimum thickness of 1 mm

⁵⁾ Standard clamping hub diameter

SP+ 140 MF 2-stage

			2-stage												
Ratio	<i>i</i>		16	20	25	28	32	35	40	50	64	70	100		
Max. torque ^{a) b) e)}	T_{2a}	Nm	726	726	670	726	726	670	726	670	583	726	583		
		in.lb	6426	6426	5934	6426	6426	5934	6426	5934	5160	6426	5160		
Max. acceleration torque ^{b) e)} (max. 1000 cycles per hour)	T_{2B}	Nm	726	726	670	726	726	670	726	670	583	726	583		
		in.lb	6426	6426	5934	6426	6426	5934	6426	5930	5164	6426	5160		
Nominal torque (at n_n)	T_{2N}	Nm	461	493	489	545	464	536	581	536	466	581	466		
		in.lb	4078	4361	4332	4824	4104	4747	5141	4747	4128	5141	4128		
Emergency stop torque ^{a) b) e)} (permitted 1000 times during the service life of the gearbox)	T_{2Not}	Nm	1350	1350	1350	1350	1350	1350	1350	1350	1350	1350	1250		
		in.lb	11949	11949	11949	11949	11949	11949	11949	11949	11949	11949	11064		
Permitted average input speed (at T_{2a} and 20 °C ambient temperature) ^{d)}	n_{1N}	rpm	2900	2900	2900	2900	2900	2900	2900	3200	3200	3200	3900		
Max. input speed	n_{1Max}	rpm	6000	6000	6000	6000	6000	6000	6000	6000	6000	6000	6000		
Mean no load running torque ^{b)} (at $n_i = 3000$ rpm and 20 °C gearbox temperature)	T_{012}	Nm	2.4	2.1	2.0	1.8	1.6	1.2	1.2	1.1	1.1	0.88	0.80		
		in.lb	21	19	17	16	14	11	11	9.4	9.4	7.8	7.1		
Max. backlash	j_t	arcmin	Standard ≤ 5 / Reduced ≤ 3												
Torsional rigidity ^{b)}	C_{121}	Nm/arcmin	53												
		in.lb/arcmin	469												
Max. axial force ^{c)}	F_{2AMax}	N	9870												
		lb _f	2221												
Max. lateral force ^{c)}	F_{2QMax}	N	9900												
		lb _f	2228												
Max. tilting moment	M_{2KMax}	Nm	952												
		in.lb	8426												
Efficiency at full load	η	%	94												
Service life	L_h	h	> 20000												
Weight (incl. standard adapter plate)	m	kg	17												
		lb _m	37.6												
Operating noise (at reference ratio and reference speed – ratio-specific values available in cymex [®])	L_{pA}	dB(A)	≤ 59												
Max. permitted housing temperature		°C	+90												
		F	194												
Ambient temperature		°C	-15 to +40												
		F	5 to 104												
Lubrication			Lubricated for life												
Direction of rotation			In- and output same direction												
Protection class			IP 65												
Metal bellows coupling (recommended product type – validate sizing with cymex [®])			BC2-00800AA040.000-X												
Bore diameter of coupling on the application side		mm	X = 040.000 - 075.000												
Mass moment of inertia (relates to the drive) Clamping hub diameter [mm] Optimized mass inertia version available on request	E	19	J_i	kgcm ²	2.50	2.01	1.97	1.65	1.65	1.63	1.40	1.39	1.39	1.38	1.38
				10 ⁻³ in.lb.s ²	2.21	1.78	1.74	1.46	1.46	1.44	1.24	1.23	1.23	1.22	1.22
	G	24	J_i	kgcm ²	3.19	2.71	2.67	2.34	2.34	2.32	2.10	2.08	2.08	2.08	2.07
				10 ⁻³ in.lb.s ²	2.82	2.40	2.36	2.07	2.07	2.05	1.86	1.84	1.84	1.84	1.83
	K	38	J_i	kgcm ²	10.3	9.77	9.73	9.41	9.41	9.39	9.16	9.15	9.15	9.14	9.14
				10 ⁻³ in.lb.s ²	9.07	8.65	8.61	8.33	8.33	8.31	8.11	8.10	8.10	8.09	8.09

Please use our sizing software cymex[®] for a detailed sizing – www.wittenstein-cymex.com

^{a)} At max. 10 % F_{2QMax}

^{b)} Valid for standard clamping hub diameter

^{c)} Refers to center of the output shaft or flange

^{d)} Please reduce input speed at higher ambient temperatures

^{e)} Smooth shaft

View A

View B

2-stage

up to 19⁴⁾ (E)
clamping hub diameter

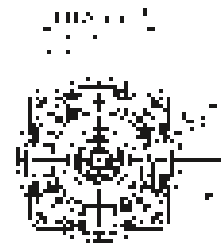
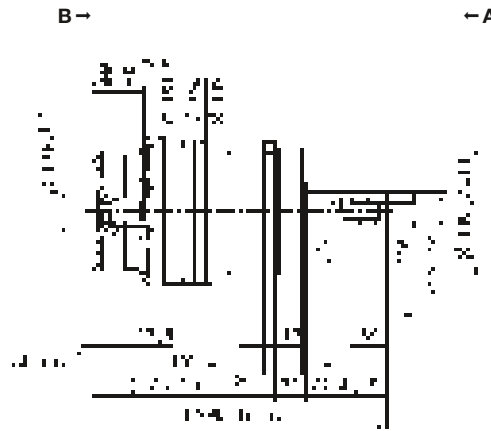
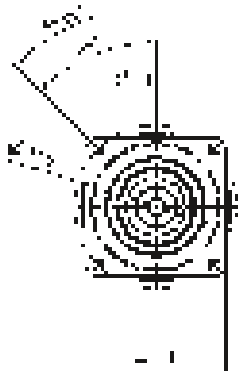

up to 24⁴⁾ (G)⁵⁾
clamping hub diameter

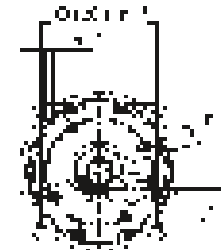
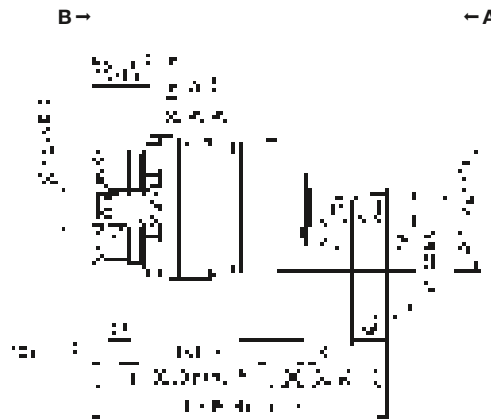
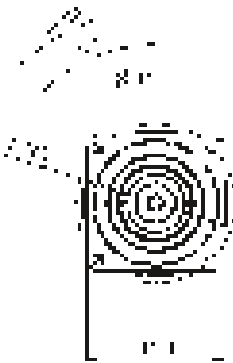

up to 38⁴⁾ (K)
clamping hub diameter

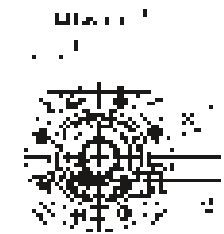
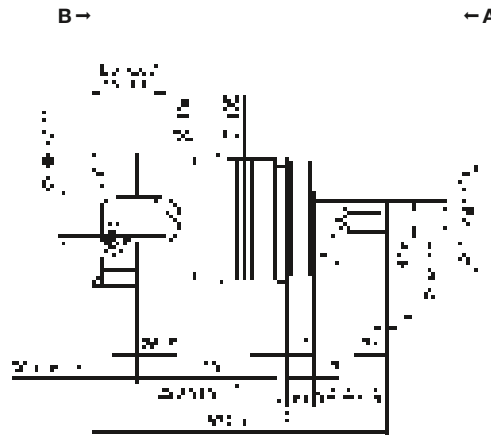
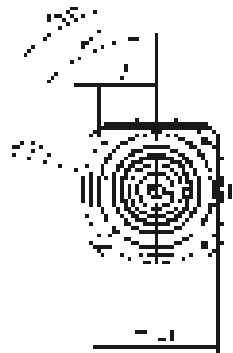

Motor shaft diameter [mm]

Other output variants

Shaft with key

Splined shaft (DIN 5480)

Shaft mounted

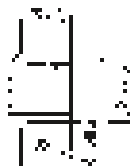
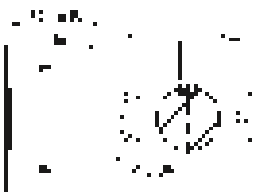

Non-tolerated dimensions are nominal dimensions

¹⁾ Check motor shaft fit

²⁾ Min./Max. permissible motor shaft length. Longer motor shafts are possible, please contact alpha.

³⁾ The dimensions depend on the motor

⁴⁾ Smaller motor shaft diameter is compensated by a bushing with a minimum thickness of 1 mm

⁵⁾ Standard clamping hub diameter

SP+ 180 MF 1-stage

			1-stage							
Ratio	<i>i</i>		3	4	5	7	8	10		
Max. torque ^{a) b) e)}	T_{2a}	Nm	1552	1936	1936	1936	1552	1552		
		in.lb	13736	17135	17135	17135	13736	13736		
Max. acceleration torque ^{b) e)} (max. 1000 cycles per hour)	T_{2B}	Nm	1164	1452	1452	1452	1164	1164		
		in.lb	10302	12851	12851	12851	10302	10302		
Nominal torque (at n_n)	T_{2N}	Nm	513	927	919	825	825	864		
		in.lb	4544	8203	8134	7305	7305	7644		
Emergency stop torque ^{a) b) e)} (permitted 1000 times during the service life of the gearbox)	T_{2Not}	Nm	2750	2750	2750	2750	2750	2750		
		in.lb	24340	24340	24340	24340	24340	24340		
Permitted average input speed (at T_{2a} and 20 °C ambient temperature) ^{d)}	n_{1N}	rpm	1500	1500	1500	2300	2300	2300		
Max. input speed	n_{1Max}	rpm	4500	4500	4500	4500	4500	4500		
Mean no load running torque ^{b)} (at $n_i = 3000$ rpm and 20 °C gearbox temperature)	T_{012}	Nm	15	12	8.0	5.6	5.6	3.8		
		in.lb	135	103	71	50	50	34		
Max. backlash	j_t	arcmin	Standard ≤ 3 / Reduced ≤ 1							
Torsional rigidity ^{b)}	C_{121}	Nm/arcmin	175							
		in.lb/arcmin	1549							
Max. axial force ^{c)}	F_{2AMax}	N	15570							
		lb _f	3503							
Max. lateral force ^{c)}	F_{2QMax}	N	15400							
		lb _f	3465							
Max. tilting moment	M_{2KMax}	Nm	1600							
		in.lb	14161							
Efficiency at full load	η	%	97							
Service life	L_h	h	> 20000							
Weight (incl. standard adapter plate)	m	kg	34							
		lb _m	75.1							
Operating noise (at reference ratio and reference speed – ratio-specific values available in cymex [®])	L_{pA}	dB(A)	≤ 62							
Max. permitted housing temperature		°C	+90							
		F	194							
Ambient temperature		°C	-15 to +40							
		F	5 to 104							
Lubrication			Lubricated for life							
Direction of rotation			In- and output same direction							
Protection class			IP 65							
Metal bellows coupling (recommended product type – validate sizing with cymex [®])			BC2-01500AA055.000-X							
Bore diameter of coupling on the application side		mm	X = 050.000 - 080.000							
Mass moment of inertia (relates to the drive) Clamping hub diameter [mm] Optimized mass inertia version available on request	K	38	J_i	kgcm ²	50.8	33.9	27.9	22.2	22.2	19.2
				10 ⁻³ in.lb.s ²	45.0	30.0	24.7	19.7	19.7	17.0
	M	48	J_i	kgcm ²	58.2	41.2	35.3	29.6	29.6	26.5
				10 ⁻³ in.lb.s ²	51.5	36.5	31.2	26.2	26.2	23.5
	N	55	J_i	kgcm ²	65.7	49.7	44.0	38.5	38.5	35.4
				10 ⁻³ in.lb.s ²	58.1	44.0	38.9	34.1	34.1	31.3

Please use our sizing software cymex[®] for a detailed sizing – www.wittenstein-cymex.com

^{a)} At max. 10 % F_{2QMax}

^{b)} Valid for standard clamping hub diameter

^{c)} Refers to center of the output shaft or flange

^{d)} Please reduce input speed at higher ambient temperatures

^{e)} Smooth shaft

View A

View B

1-stage

up to 38⁴⁾ (K)
clamping hub diameter

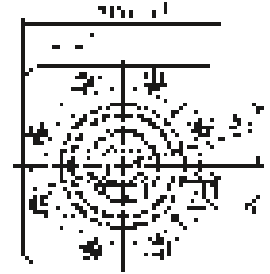
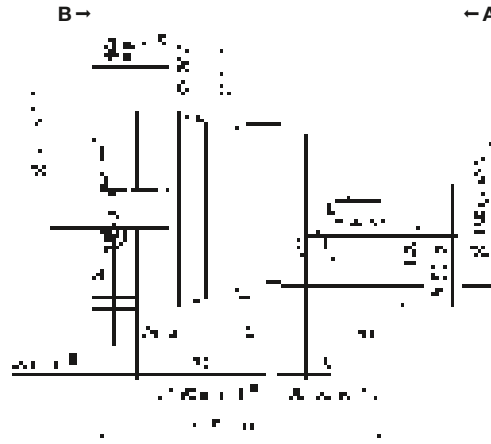
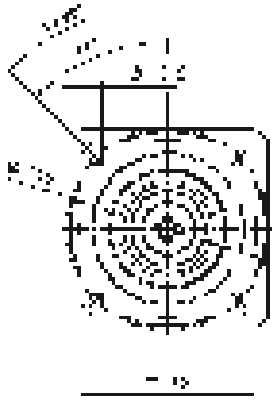

up to 48⁴⁾ (M)⁵⁾
clamping hub diameter

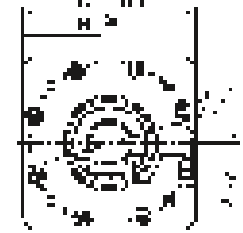
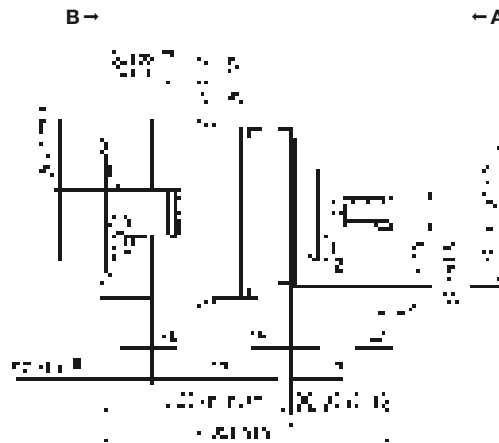
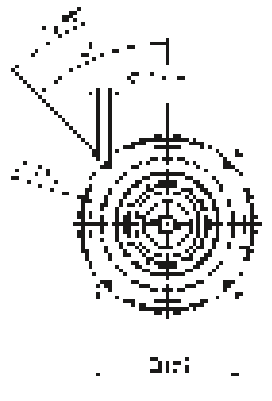

up to 55⁴⁾ (N)⁵⁾
clamping hub diameter

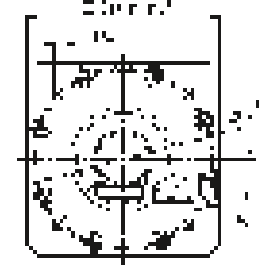
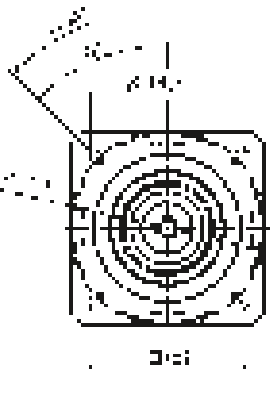

Motor shaft diameter [mm]

Planetary gearboxes

SP¹⁾
MF

Other output variants

Shaft with key



Splined shaft (DIN 5480)

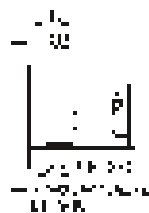

Shaft mounted



Non-tolerated dimensions are nominal dimensions

¹⁾ Check motor shaft fit

²⁾ Min./Max. permissible motor shaft length. Longer motor shafts are possible, please contact alpha.

³⁾ The dimensions depend on the motor

⁴⁾ Smaller motor shaft diameter is compensated by a bushing with a minimum thickness of 1 mm

⁵⁾ Standard clamping hub diameter

SP+ 180 MF 2-stage

			2-stage												
Ratio	<i>i</i>		16	20	25	28	32	35	40	50	64	70	100		
Max. torque ^{a) b) e)}	T_{2a}	Nm	1485	1485	1857	1485	1485	1857	1485	1857	1238	1356	1238		
		in.lb	13146	13146	16432	13146	13146	16432	13146	16432	10955	12000	10955		
Max. acceleration torque ^{b) e)} (max. 1000 cycles per hour)	T_{2B}	Nm	1452	1452	1452	1452	1452	1452	1452	1452	1164	1356	1164		
		in.lb	12851	12851	12851	12851	12851	12851	12851	12851	10302	12002	10302		
Nominal torque (at n_{1N})	T_{2N}	Nm	1162	1162	1162	1162	1162	1162	1162	1162	931	1085	931		
		in.lb	10281	10281	10281	10281	10281	10281	10281	10281	8242	9600	8242		
Emergency stop torque ^{a) b) e)} (permitted 1000 times during the service life of the gearbox)	T_{2Not}	Nm	2750	2750	2750	2750	2750	2750	2750	2750	2750	2750	2750		
		in.lb	24340	24340	24340	24340	24340	24340	24340	24340	24340	24340	24340		
Permitted average input speed (at T_{2a} and 20 °C ambient temperature) ^{d)}	n_{1N}	rpm	2700	2700	2700	2700	2700	2700	2700	2900	2900	3200	3400		
Max. input speed	n_{1Max}	rpm	5000	5000	5000	5000	5000	5000	5000	5000	5000	5000	5000		
Mean no load running torque ^{b)} (at $n_1 = 3000$ rpm and 20 °C gearbox temperature)	T_{012}	Nm	4.7	3.9	3.6	3.3	3.3	2.8	2.2	1.9	1.9	1.8	1.8		
		in.lb	42	35	32	29	29	25	20	17	17	16	16		
Max. backlash	j_t	arcmin	Standard ≤ 5 / Reduced ≤ 3												
Torsional rigidity ^{b)}	C_{121}	Nm/arcmin	175												
		in.lb/arcmin	1549												
Max. axial force ^{c)}	F_{2AMax}	N	15570												
		lb _f	3503												
Max. lateral force ^{c)}	F_{2QMax}	N	15400												
		lb _f	3465												
Max. tilting moment	M_{2KMax}	Nm	1600												
		in.lb	14161												
Efficiency at full load	η	%	94												
Service life	L_h	h	> 20000												
Weight (incl. standard adapter plate)	m	kg	36.4												
		lb _m	80.4												
Operating noise (at reference ratio and reference speed – ratio-specific values available in cymex [®])	L_{pA}	dB(A)	≤ 58												
Max. permitted housing temperature		°C	+90												
		F	194												
Ambient temperature		°C	-15 to +40												
		F	5 to 104												
Lubrication			Lubricated for life												
Direction of rotation			In- and output same direction												
Protection class			IP 65												
Metal bellows coupling (recommended product type – validate sizing with cymex [®])			BC2-01500AA055.000-X												
Bore diameter of coupling on the application side		mm	X = 050.000 - 080.000												
Mass moment of inertia (relates to the drive) Clamping hub diameter [mm] Optimized mass inertia version available on request	G	24	J_1	kgcm ²	9.27	7.72	7.48	6.32	6.32	6.20	5.51	5.45	5.39	5.36	
				10 ⁻³ in.lb.s ²	8.20	6.83	6.62	5.59	5.59	5.49	4.88	4.82	4.82	4.77	4.74
	I	32	J_1	kgcm ²	12.4	10.9	10.6	9.48	9.48	9.36	8.67	9.68	8.55	8.55	8.52
				10 ⁻³ in.lb.s ²	11.0	9.63	9.42	8.39	8.39	8.28	7.67	8.57	7.57	7.57	7.54
	K	38	J_1	kgcm ²	13.5	12.0	11.7	10.6	10.6	10.4	9.74	9.68	9.63	9.60	
				10 ⁻³ in.lb.s ²	12.0	10.6	10.4	9.34	9.34	9.23	8.62	8.57	8.57	8.52	8.50
	M	48	J_1	kgcm ²	28.1	26.6	26.3	25.2	25.2	25.1	24.4	24.3	24.3	24.3	24.3
				10 ⁻³ in.lb.s ²	24.9	23.5	23.3	22.3	22.3	22.2	21.6	21.5	21.5	21.5	21.5

Please use our sizing software cymex[®] for a detailed sizing – www.wittenstein-cymex.com

^{a)} At max. 10 % F_{2QMax}

^{b)} Valid for standard clamping hub diameter

^{c)} Refers to center of the output shaft or flange

^{d)} Please reduce input speed at higher ambient temperatures

^{e)} Smooth shaft

View A

View B

2-stage

up to 24⁴⁾ (G)
clamping hub diameter

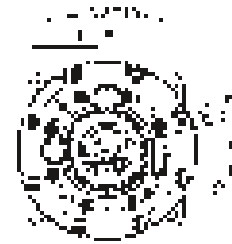
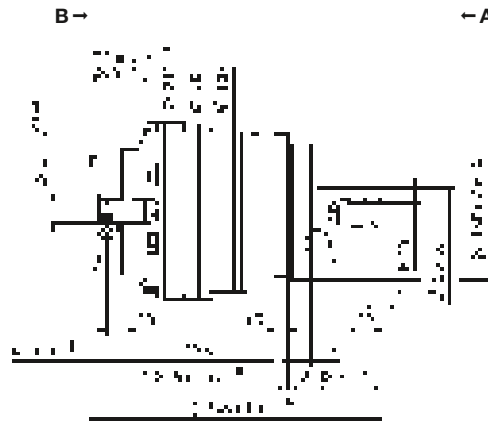
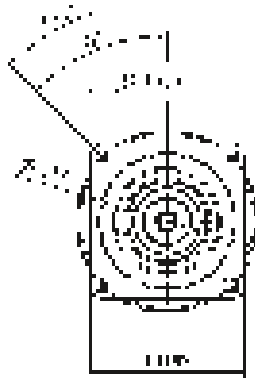

up to 32/38⁴⁾
(I/K⁵⁾ clamping hub diameter

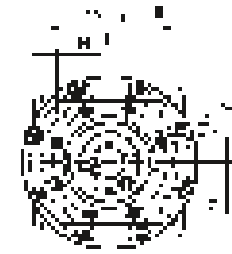
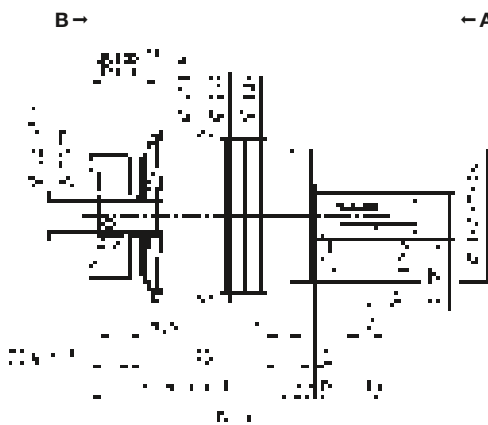
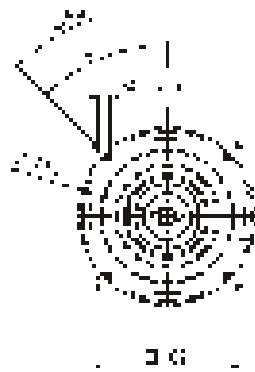

up to 48⁴⁾ (M)
clamping hub diameter

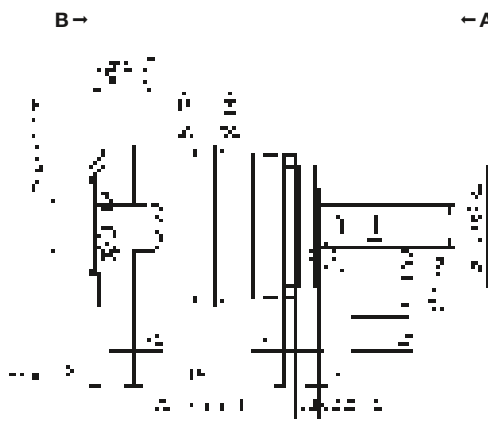
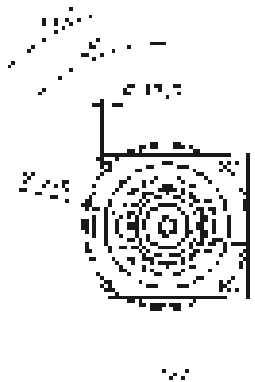

Other output variants

Shaft with key



Splined shaft (DIN 5480)

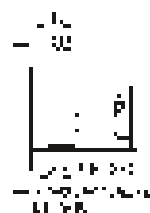

Shaft mounted



Non-tolerated dimensions are nominal dimensions

¹⁾ Check motor shaft fit

²⁾ Min./Max. permissible motor shaft length. Longer motor shafts are possible, please contact alpha.

³⁾ The dimensions depend on the motor

⁴⁾ Smaller motor shaft diameter is compensated by a bushing with a minimum thickness of 1 mm

⁵⁾ Standard clamping hub diameter

SP+ 210 MF 1-stage

			1-stage							
Ratio	<i>i</i>		3	4	5	7	8	10		
Max. torque ^{a) b) e)}	T_{2a}	Nm	2560	4000	4000	3840	2800	2800		
		in.lb	22658	35403	35403	33987	24782	24782		
Max. acceleration torque ^{b) e)} (max. 1000 cycles per hour)	T_{2B}	Nm	1920	3000	3000	2880	2280	2280		
		in.lb	16994	26552	26552	25490	20180	20180		
Nominal torque (at n_N)	T_{2N}	Nm	1536	1895	1767	1731	1631	1708		
		in.lb	13595	16772	15641	15323	14432	15122		
Emergency stop torque ^{a) b) e)} (permitted 1000 times during the service life of the gearbox)	T_{2Not}	Nm	5900	5900	5900	5900	5900	5900		
		in.lb	52220	52220	52220	52220	52220	52220		
Permitted average input speed (at T_{2a} and 20 °C ambient temperature) ^{d)}	n_{1N}	rpm	1200	1200	1500	1700	2000	2000		
Max. input speed	n_{1Max}	rpm	3000	3000	3000	3000	3000	3000		
Mean no load running torque ^{b)} (at $n_1 = 2000$ rpm and 20 °C gearbox temperature)	T_{012}	Nm	26	19	15	8.8	8.8	6.4		
		in.lb	227	164	129	78	78	57		
Max. backlash	j_t	arcmin	Standard ≤ 3 / Reduced ≤ 1							
Torsional rigidity ^{b)}	C_{121}	Nm/arcmin	400							
		in.lb/arcmin	3540							
Max. axial force ^{c)}	F_{2AMax}	N	30000							
		lb _f	6750							
Max. lateral force ^{c)}	F_{2QMax}	N	21000							
		lb _f	4725							
Max. tilting moment	M_{2KMax}	Nm	3100							
		in.lb	27437							
Efficiency at full load	η	%	97							
Service life	L_h	h	> 20000							
Weight (incl. standard adapter plate)	m	kg	56							
		lb _m	123.8							
Operating noise (at reference ratio and reference speed – ratio-specific values available in cymex [®])	L_{pA}	dB(A)	≤ 64							
Max. permitted housing temperature		°C	+90							
		F	194							
Ambient temperature		°C	-15 to +40							
		F	5 to 104							
Lubrication			Lubricated for life							
Direction of rotation			In- and output same direction							
Protection class			IP 65							
Metal bellows coupling (recommended product type – validate sizing with cymex [®])			BC2-04000AA075.000-X							
Bore diameter of coupling on the application side		mm	X = 050.000 - 090.000							
Mass moment of inertia (relates to the drive) Clamping hub diameter [mm] Optimized mass inertia version available on request	N	55	J_1	kgcm ²	139	94.3	76.9	61.5	61.5	53.1
				10 ⁻³ in.lb.s ²	123	83.5	68.1	54.4	54.4	47.0

Please use our sizing software cymex[®] for a detailed sizing – www.wittenstein-cymex.com

^{a)} At max. 10 % F_{2QMax}

^{b)} Valid for standard clamping hub diameter

^{c)} Refers to center of the output shaft or flange

^{d)} Please reduce input speed at higher ambient temperatures

^{e)} Smooth shaft

View A

View B

Motor shaft diameter [mm]

1-stage

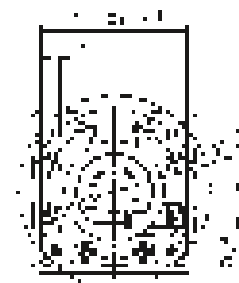
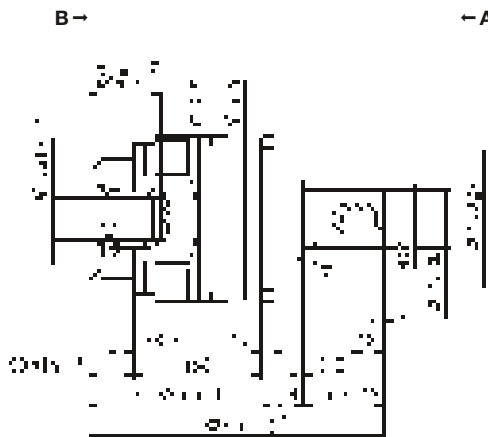
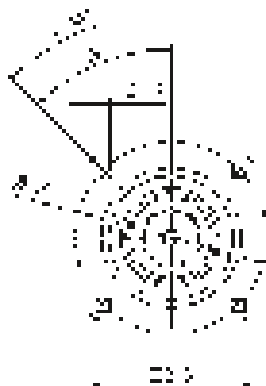
 up to 55⁴⁾ (N)⁵⁾
 clamping hub diameter

Planetary gearboxes

SP+

MF

Other output variants

Shaft with key

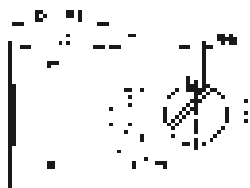

Splined shaft (DIN 5480)

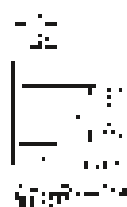

Non-tolerated dimensions are nominal dimensions

¹⁾ Check motor shaft fit

²⁾ Min./Max. permissible motor shaft length. Longer motor shafts are possible, please contact alpha.

³⁾ The dimensions depend on the motor

⁴⁾ Smaller motor shaft diameter is compensated by a bushing with a minimum thickness of 1 mm

⁵⁾ Standard clamping hub diameter

SP+ 210 MF 2-stage

				2-stage											
Ratio	<i>i</i>			16	20	25	28	32	35	40	50	64	70	100	
Max. torque ^{a) b) e)}	T_{2a}	<i>Nm</i>		3159	3159	3949	3159	3159	3840	2880	3600	2043	2457	2043	
		<i>in.lb</i>		27958	27958	34947	27958	27958	33987	25490	31863	18081	21745	18081	
Max. acceleration torque ^{b) e)} (max. 1000 cycles per hour)	T_{2B}	<i>Nm</i>		2880	3000	3000	2880	2880	2880	2840	2880	2043	2457	2043	
		<i>in.lb</i>		25490	26552	26552	25490	25490	25490	25136	25490	18081	21745	18081	
Nominal torque (at n_{1N})	T_{2N}	<i>Nm</i>		1274	1266	1567	1294	2200	1599	1358	1679	1634	1965	1634	
		<i>in.lb</i>		11277	11205	13873	11452	19474	14150	12019	14861	14465	17396	14465	
Emergency stop torque ^{a) b) e)} (permitted 1000 times during the service life of the gearbox)	T_{2Not}	<i>Nm</i>		5900	5900	5900	5900	5900	5900	5900	5900	5900	5900	5900	
		<i>in.lb</i>		52220	52220	52220	52220	52220	52220	52220	52220	52220	52220	52220	
Permitted average input speed (at T_{2a} and 20 °C ambient temperature) ^{d)}	n_{1N}	<i>rpm</i>		2500	2500	2500	2500	2500	2500	2500	2500	2500	3000	3000	
Max. input speed	n_{1Max}	<i>rpm</i>		4500	4500	4500	4500	4500	4500	4500	4500	4500	4500	4500	
Mean no load running torque ^{b)} (at $n_1 = 2000$ rpm and 20 °C gearbox temperature)	T_{012}	<i>Nm</i>		5.6	5.2	4.8	4.5	4.5	3.6	3.4	3.0	3.0	2.6	2.4	
		<i>in.lb</i>		50	46	43	39	39	32	30	27	27	23	21	
Max. backlash	j_t	<i>arcmin</i>		Standard ≤ 5 / Reduced ≤ 3											
Torsional rigidity ^{b)}	C_{121}	<i>Nm/arcmin</i>		400											
		<i>in.lb/arcmin</i>		3540											
Max. axial force ^{c)}	F_{2AMax}	<i>N</i>		30000											
		<i>lb_f</i>		6750											
Max. lateral force ^{c)}	F_{2QMax}	<i>N</i>		21000											
		<i>lb_f</i>		4725											
Max. tilting moment	M_{2KMax}	<i>Nm</i>		3100											
		<i>in.lb</i>		27437											
Efficiency at full load	η	%		94											
Service life	L_h	<i>h</i>		> 20000											
Weight (incl. standard adapter plate)	m	<i>kg</i>		53											
		<i>lb_m</i>		117											
Operating noise (at reference ratio and reference speed – ratio-specific values available in cymex [®])	L_{pA}	<i>dB(A)</i>		≤ 57											
Max. permitted housing temperature		°C		+90											
		<i>F</i>		194											
Ambient temperature		°C		-15 to +40											
		<i>F</i>		5 to 104											
Lubrication				Lubricated for life											
Direction of rotation				In- and output same direction											
Protection class				IP 65											
Metal bellows coupling (recommended product type – validate sizing with cymex [®])				BC2-04000AA075.000-X											
Bore diameter of coupling on the application side		<i>mm</i>		X = 050.000 - 090.000											
Mass moment of inertia (relates to the drive) Clamping hub diameter [mm] Optimized mass inertia version available on request	M	48	J_1	<i>kgcm²</i>	34.5	31.5	30.8	30.0	30.0	29.7	28.5	28.3	28.3	28.1	28.0
				<i>10⁻³ in.lb.s²</i>	30.5	27.9	27.3	26.6	26.6	26.3	25.2	25.0	25.0	24.9	24.8

Please use our sizing software cymex[®] for a detailed sizing – www.wittenstein-cymex.com

- ^{a)} At max. 10 % F_{2QMax}
- ^{b)} Valid for standard clamping hub diameter
- ^{c)} Refers to center of the output shaft or flange
- ^{d)} Please reduce input speed at higher ambient temperatures
- ^{e)} Smooth shaft

View A

View B

Motor shaft diameter [mm]

2-stage

up to 48⁴⁾ (M)⁵⁾
clamping hub diameter

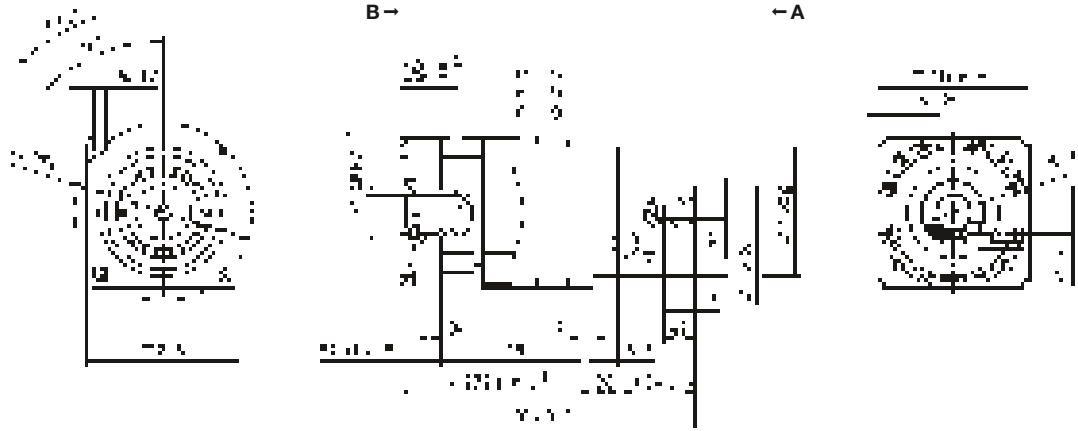

Planetary gearboxes

SP+

MF

Other output variants

Shaft with key

Splined shaft (DIN 5480)

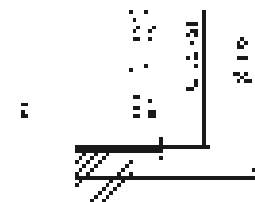
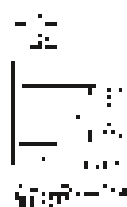
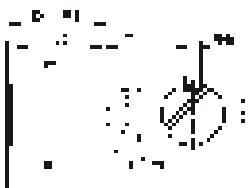

Non-tolerated dimensions are nominal dimensions

¹⁾ Check motor shaft fit

²⁾ Min./Max. permissible motor shaft length. Longer motor shafts are possible, please contact alpha.

³⁾ The dimensions depend on the motor

⁴⁾ Smaller motor shaft diameter is compensated by a bushing with a minimum thickness of 1 mm

⁵⁾ Standard clamping hub diameter

SP+ 240 MF 1-stage

			1-stage						
Ratio	<i>i</i>		3	4	5	7	8	10	
Max. torque ^{a) b) e)}	T_{2a}	Nm	4400	5700	5700	5700	4000	4000	
		in.lb	38944	50450	50450	50450	35403	35403	
Max. acceleration torque ^{b) e)} (max. 1000 cycles per hour)	T_{2B}	Nm	3300	5400	5400	5160	4000	4000	
		in.lb	29208	47794	47794	45670	35403	35403	
Nominal torque (at n_n)	T_{2N}	Nm	2333	3038	2872	2737	2611	2735	
		in.lb	20651	26885	25418	24223	23111	24208	
Emergency stop torque ^{a) b) e)} (permitted 1000 times during the service life of the gearbox)	T_{2Not}	Nm	6850	8500	8500	8500	6850	6850	
		in.lb	60628	75232	75232	75232	60628	60628	
Permitted average input speed (at T_{2a} and 20 °C ambient temperature) ^{d)}	n_{1N}	rpm	1000	1000	1200	1500	1700	1700	
Max. input speed	n_{1Max}	rpm	3000	3000	3000	3000	3000	3000	
Mean no load running torque ^{b)} (at $n_1 = 2000$ rpm and 20 °C gearbox temperature)	T_{012}	Nm	32	24	19	12	12	8.0	
		in.lb	283	212	164	106	106	71	
Max. backlash	j_t	arcmin	Standard ≤ 3 / Reduced ≤ 1						
Torsional rigidity ^{b)}	C_{121}	Nm/arcmin	550						
		in.lb/arcmin	4868						
Max. axial force ^{c)}	F_{2AMax}	N	33000						
		lb _f	7425						
Max. lateral force ^{c)}	F_{2QMax}	N	30000						
		lb _f	6750						
Max. tilting moment	M_{2KMax}	Nm	5000						
		in.lb	44254						
Efficiency at full load	η	%	97						
Service life	L_h	h	> 20000						
Weight (incl. standard adapter plate)	m	kg	77						
		lb _m	170.2						
Operating noise (at reference ratio and reference speed – ratio-specific values available in cymex [®])	L_{pA}	dB(A)	≤ 66						
		°C	+90						
Max. permitted housing temperature	F	°C	+90						
		F	194						
Ambient temperature	F	°C	-15 to +40						
		F	5 to 104						
Lubrication			Lubricated for life						
Direction of rotation			In- and output same direction						
Protection class			IP 65						
Metal bellows coupling (recommended product type – validate sizing with cymex [®])			BC2-06000AA085.000-X						
	Bore diameter of coupling on the application side	mm	X = 060.000 - 140.000						
Mass moment of inertia (relates to the drive) Clamping hub diameter [mm] Optimized mass inertia version available on request	O 60	J_1	kgcm ²	260	198	163	138	138	125
			10 ⁻³ in.lb.s ²	230	175	144	122	122	110

Please use our sizing software cymex[®] for a detailed sizing – www.wittenstein-cymex.com

^{a)} At max. 10 % F_{2QMax}

^{b)} Valid for standard clamping hub diameter

^{c)} Refers to center of the output shaft or flange

^{d)} Please reduce input speed at higher ambient temperatures

^{e)} Smooth shaft

View A

View B

Motor shaft diameter [mm]

1-stage

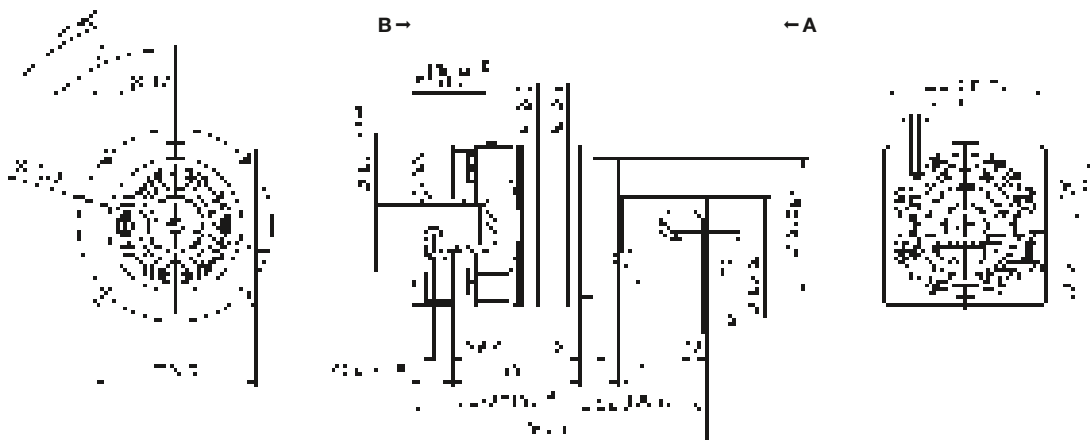
 up to 60⁴⁾ (O)⁵⁾
 clamping hub diameter

Planetary gearboxes

SP+

MF

Other output variants

Shaft with key

Splined shaft (DIN 5480)

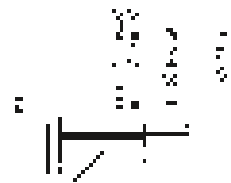
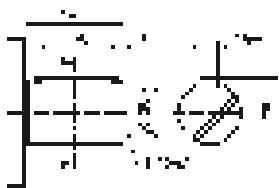

Non-tolerated dimensions are nominal dimensions

¹⁾ Check motor shaft fit

²⁾ Min./Max. permissible motor shaft length. Longer motor shafts are possible, please contact alpha.

³⁾ The dimensions depend on the motor

⁴⁾ Smaller motor shaft diameter is compensated by a bushing with a minimum thickness of 1 mm

⁵⁾ Standard clamping hub diameter

SP+ 240 MF 2-stage

				2-stage											
Ratio	<i>i</i>			16	20	25	28	32	35	40	50	64	70	100	
Max. torque ^{a) b) e)}	T_{2a}	<i>Nm</i>		5446	5446	5700	5446	5446	5700	5446	5700	3642	5700	3642	
		<i>in.lb</i>		48202	48202	50450	48202	48202	50450	48202	50450	32236	50450	32236	
Max. acceleration torque ^{b) e)} (max. 1000 cycles per hour)	T_{2B}	<i>Nm</i>		5400	5400	5400	5400	5400	5400	4400	5160	3642	4730	3642	
		<i>in.lb</i>		47794	47794	47794	47794	47794	47794	38944	45670	32236	41864	32236	
Nominal torque (at n_{1N})	T_{2N}	<i>Nm</i>		2658	2596	3198	2667	3754	3283	2803	3457	2914	3784	2914	
		<i>in.lb</i>		23524	22976	28308	23607	33222	29060	24811	30600	25789	33491	25789	
Emergency stop torque ^{a) b) e)} (permitted 1000 times during the service life of the gearbox)	T_{2Not}	<i>Nm</i>		8500	8500	8500	8500	8500	8500	8500	8500	6850	8500	6850	
		<i>in.lb</i>		75232	75232	75232	75232	75232	75232	75232	75232	60628	75232	60628	
Permitted average input speed (at T_{2a} and 20 °C ambient temperature) ^{d)}	n_{1N}	<i>rpm</i>		2300	2500	2500	2500	2500	2500	2500	2500	2500	2800	2800	
Max. input speed	n_{1Max}	<i>rpm</i>		4500	4500	4500	4500	4500	4500	4500	4500	4500	4500	4500	
Mean no load running torque ^{b)} (at $n_1 = 2000$ rpm and 20 °C gearbox temperature)	T_{012}	<i>Nm</i>		8.4	7.1	6.5	5.9	5.9	4.5	4.1	3.5	3.5	3.0	3.0	
		<i>in.lb</i>		74	63	58	52	52	40	36	31	31	26	26	
Max. backlash	j_t	<i>arcmin</i>		Standard ≤ 5 / Reduced ≤ 3											
Torsional rigidity ^{b)}	C_{121}	<i>Nm/arcmin</i>		550											
		<i>in.lb/arcmin</i>		4868											
Max. axial force ^{c)}	F_{2AMax}	<i>N</i>		33000											
		<i>lb_f</i>		7425											
Max. lateral force ^{c)}	F_{2QMax}	<i>N</i>		30000											
		<i>lb_f</i>		6750											
Max. tilting moment	M_{2KMax}	<i>Nm</i>		5000											
		<i>in.lb</i>		44254											
Efficiency at full load	η	%		94											
Service life	L_h	<i>h</i>		> 20000											
Weight (incl. standard adapter plate)	<i>m</i>	<i>kg</i>		76											
		<i>lb_m</i>		168											
Operating noise (at reference ratio and reference speed – ratio-specific values available in cymex [®])	L_{pA}	<i>dB(A)</i>		≤ 58											
Max. permitted housing temperature		°C		+90											
		<i>F</i>		194											
Ambient temperature		°C		-15 to +40											
		<i>F</i>		5 to 104											
Lubrication				Lubricated for life											
Direction of rotation				In- and output same direction											
Protection class				IP 65											
Metal bellows coupling (recommended product type – validate sizing with cymex [®])				BC2-06000AA085.000-X											
Bore diameter of coupling on the application side		<i>mm</i>		X = 060.000 - 140.000											
Mass moment of inertia (relates to the drive) Clamping hub diameter [mm] Optimized mass inertia version available on request	M	48	J_1	<i>kgcm²</i>	39.2	34.6	33.2	30.5	30.5	29.7	28.2	27.9	27.6	27.6	27.5
				<i>10⁻³ in.lb.s²</i>	34.7	30.6	29.4	27.0	27.0	26.3	25.0	24.7	24.4	24.4	24.3

Please use our sizing software cymex[®] for a detailed sizing – www.wittenstein-cymex.com

^{a)} At max. 10 % F_{2QMax}

^{b)} Valid for standard clamping hub diameter

^{c)} Refers to center of the output shaft or flange

^{d)} Please reduce input speed at higher ambient temperatures

^{e)} Smooth shaft

View A

View B

Motor shaft diameter [mm]

2-stage

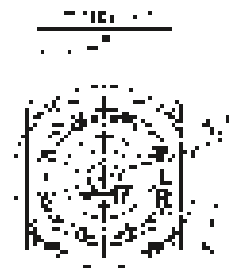
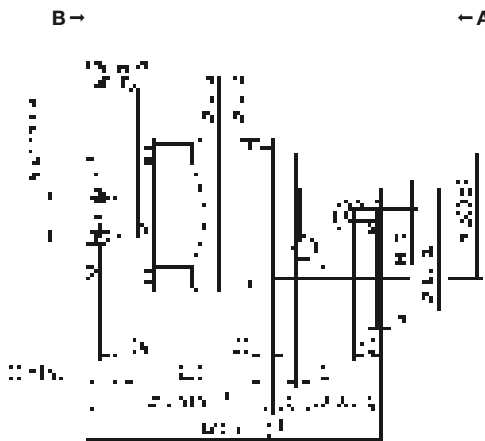
 up to 48⁴⁾ (M)⁵⁾
 clamping hub diameter

Planetary gearboxes

SP+

MF

Other output variants

Shaft with key

Splined shaft (DIN 5480)

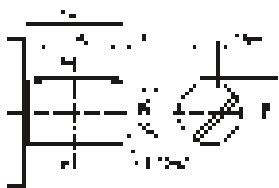

- Non-tolerated dimensions are nominal dimensions
- ¹⁾ Check motor shaft fit
 - ²⁾ Min./Max. permissible motor shaft length. Longer motor shafts are possible, please contact alpha.
 - ³⁾ The dimensions depend on the motor
 - ⁴⁾ Smaller motor shaft diameter is compensated by a bushing with a minimum thickness of 1 mm
 - ⁵⁾ Standard clamping hub diameter

SP+ 075 MC 1-stage

			1-stage							
Ratio	<i>i</i>		3	4	5	7	8	10		
Max. torque ^{a) b) e)}	T_{2a}	Nm	68	90	90	90	70	70		
		in.lb	602	797	797	797	620	620		
Max. acceleration torque ^{b) e)} (max. 1000 cycles per hour)	T_{2B}	Nm	68	90	90	90	70	70		
		in.lb	602	797	797	797	620	620		
Nominal torque (at n_N)	T_{2N}	Nm	41	51	51	52	50	53		
		in.lb	362	448	447	459	441	468		
Emergency stop torque ^{a) b) e)} (permitted 1000 times during the service life of the gearbox)	T_{2Not}	Nm	139	185	250	250	213	213		
		in.lb	1230	1640	2213	2213	1885	1885		
Permitted average input speed (at T_{2a} and 20 °C ambient temperature) ^{d)}	n_{1N}	rpm	4500	4500	4500	4500	4500	4500		
Max. input speed	n_{1Max}	rpm	6000	6000	6000	6000	6000	6000		
Mean no load running torque ^{b)} (at $n_1 = 3000$ rpm and 20 °C gearbox temperature)	T_{012}	Nm	1.1	0.88	0.72	0.49	0.42	0.40		
		in.lb	9.9	7.8	6.4	4.3	3.7	3.5		
Max. backlash	j_t	arcmin	Standard ≤ 6 / Reduced ≤ 4							
Torsional rigidity ^{b)}	C_{121}	Nm/arcmin	10							
		in.lb/arcmin	89							
Max. axial force ^{c)}	F_{2AMax}	N	3350							
		lb _f	754							
Max. lateral force ^{c)}	F_{2QMax}	N	4200							
		lb _f	945							
Max. tilting moment	M_{2KMax}	Nm	236							
		in.lb	2089							
Efficiency at full load	η	%	98.5							
Service life	L_h	h	> 30000							
Weight (incl. standard adapter plate)	<i>m</i>	kg	3.9							
		lb _m	8.6							
Operating noise (at reference ratio and reference speed – ratio-specific values available in cymex [®])	L_{pA}	dB(A)	≤ 59							
Max. permitted housing temperature		°C	+90							
		F	194							
Ambient temperature		°C	-15 to +40							
		F	5 to 104							
Lubrication			Lubricated for life							
Direction of rotation			In- and output same direction							
Protection class			IP 65							
Metal bellows coupling (recommended product type – validate sizing with cymex [®])			BC2-00080AA022.000-X							
Bore diameter of coupling on the application side		mm	X = 014.000 - 042.000							
Mass moment of inertia (relates to the drive) Clamping hub diameter [mm]	E	19	J_1	kgcm ²	1.03	0.78	0.68	0.59	0.54	0.54
				10 ⁻³ in.lb.s ²	0.91	0.69	0.60	0.52	0.48	0.48
	G	24	J_1	kgcm ²	2.40	2.15	2.05	1.96	1.91	1.91
				10 ⁻³ in.lb.s ²	2.12	1.90	1.81	1.73	1.69	1.69

Please use our sizing software cymex[®] for a detailed sizing – www.wittenstein-cymex.com

^{a)} At max. 10 % F_{2QMax}

^{b)} Valid for standard clamping hub diameter

^{c)} Refers to center of the output shaft or flange

^{d)} Please reduce input speed at higher ambient temperatures

^{e)} Smooth shaft

View A

View B

1-stage

up to 19⁴⁾ (E)⁵⁾
clamping hub
diameter

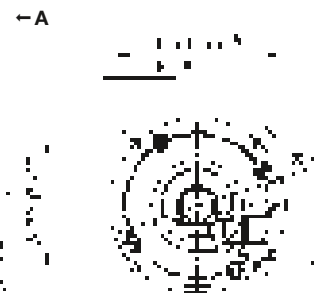
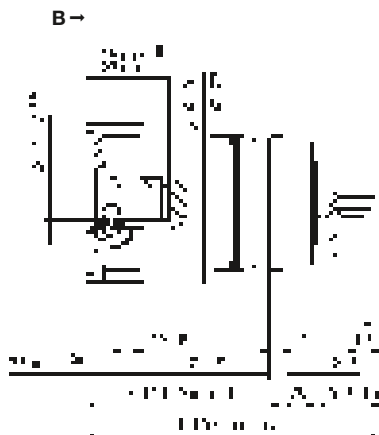
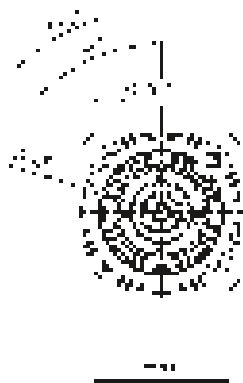

Motor shaft diameter [mm]

up to 24⁴⁾ (G)
clamping hub
diameter

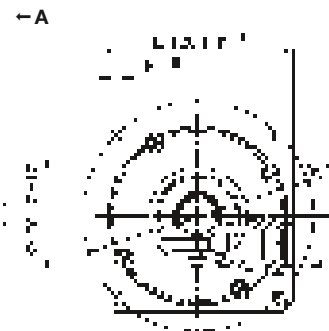
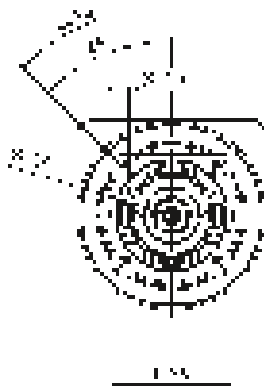

SP+

MC

Planetary gearboxes

Other output variants

Shaft with key

Splined shaft (DIN 5480)

Shaft mounted

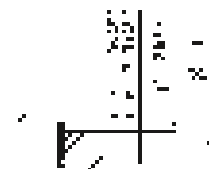
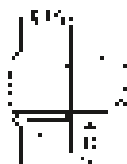
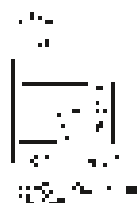

Non-tolerated dimensions are nominal dimensions

¹⁾ Check motor shaft fit

²⁾ Min./Max. permissible motor shaft length. Longer motor shafts are possible, please contact alpha.

³⁾ The dimensions depend on the motor

⁴⁾ Smaller motor shaft diameter is compensated by a bushing with a minimum thickness of 1 mm

⁵⁾ Standard clamping hub diameter

SP+ 075 MC 2-stage

			2-stage											
Ratio	<i>i</i>		16	20	25	28	32	35	40	50	64	70	100	
Max. torque ^{a) b) e)}	T_{2a}	Nm	90	90	90	90	90	90	90	90	70	90	70	
		in.lb	797	797	797	797	797	797	797	797	797	620	797	620
Max. acceleration torque ^{b) e)} (max. 1000 cycles per hour)	T_{2B}	Nm	90	90	90	90	90	90	90	90	70	90	70	
		in.lb	797	797	797	797	797	797	797	797	797	620	797	620
Nominal torque (at n_n)	T_{2N}	Nm	62	62	72	65	72	72	65	72	56	72	56	
		in.lb	552	553	637	572	637	637	574	637	496	637	496	
Emergency stop torque ^{a) b) e)} (permitted 1000 times during the service life of the gearbox)	T_{2Not}	Nm	250	250	250	250	250	250	250	250	213	250	213	
		in.lb	2213	2213	2213	2213	2213	2213	2213	2213	1885	2213	1885	
Permitted average input speed (at T_{2a} and 20 °C ambient temperature) ^{d)}	n_{1N}	rpm	4500	4500	4500	4500	4500	4500	4500	4500	4500	4500	4500	
Max. input speed	n_{1Max}	rpm	6000	6000	6000	6000	6000	6000	6000	6000	6000	6000	6000	
Mean no load running torque ^{b)} (at $n_1 = 3000$ rpm and 20 °C gearbox temperature)	T_{012}	Nm	0.36	0.24	0.18	0.18	0.17	0.16	0.16	0.16	0.16	0.15	0.14	
		in.lb	3.2	2.1	1.6	1.6	1.5	1.4	1.4	1.4	1.4	1.3	1.2	
Max. backlash	j_t	arcmin	Standard ≤ 8 / Reduced ≤ 6											
Torsional rigidity ^{b)}	C_{121}	Nm/arcmin	10											
		in.lb/arcmin	89											
Max. axial force ^{c)}	F_{2AMax}	N	3350											
		lb _f	754											
Max. lateral force ^{c)}	F_{2QMax}	N	4200											
		lb _f	945											
Max. tilting moment	M_{2KMax}	Nm	236											
		in.lb	2089											
Efficiency at full load	η	%	96.5											
Service life	L_h	h	> 30000											
Weight (incl. standard adapter plate)	m	kg	3.6											
		lb _m	8.0											
Operating noise (at reference ratio and reference speed – ratio-specific values available in cymex [®])	L_{pA}	dB(A)	≤ 55											
Max. permitted housing temperature		°C	+90											
		F	194											
Ambient temperature		°C	-15 to +40											
		F	5 to 104											
Lubrication			Lubricated for life											
Direction of rotation			In- and output same direction											
Protection class			IP 65											
Metal bellows coupling (recommended product type – validate sizing with cymex [®])			BC2-00080AA022.000-X											
Bore diameter of coupling on the application side		mm	X = 014.000 - 042.000											
Mass moment of inertia (relates to the drive) Clamping hub diameter [mm]	C	14	J_1	kgcm ²	0.23	0.20	0.20	0.18	0.18	0.18	0.16	0.16	0.16	0.16
				10 ⁻³ in.lb.s ²	0.20	0.18	0.18	0.16	0.16	0.16	0.14	0.14	0.14	0.14
	E	19	J_1	kgcm ²	0.55	0.53	0.52	0.50	0.50	0.50	0.49	0.49	0.49	0.49
				10 ⁻³ in.lb.s ²	0.49	0.47	0.46	0.44	0.44	0.44	0.43	0.43	0.43	0.43

Please use our sizing software cymex[®] for a detailed sizing – www.wittenstein-cymex.com

- ^{a)} At max. 10 % F_{2QMax}
- ^{b)} Valid for standard clamping hub diameter
- ^{c)} Refers to center of the output shaft or flange
- ^{d)} Please reduce input speed at higher ambient temperatures
- ^{e)} Smooth shaft

View A

View B

2-stage

up to 14⁴⁾ (C)⁵⁾
clamping hub
diameter

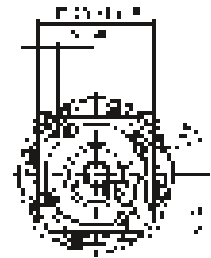
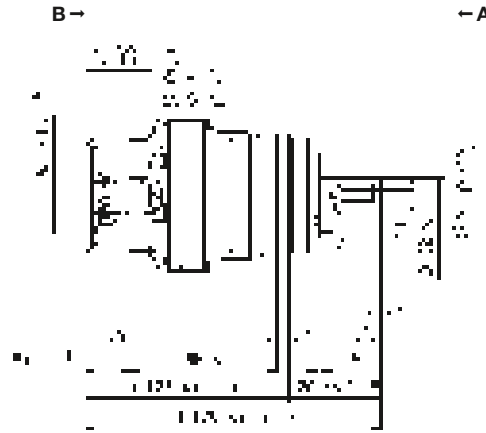
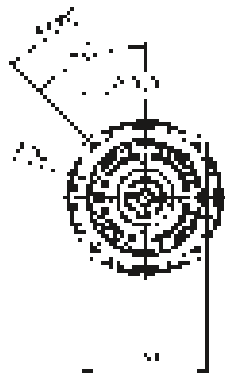

Motor shaft diameter [mm]

up to 19⁴⁾ (E)
clamping hub
diameter

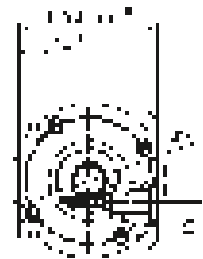
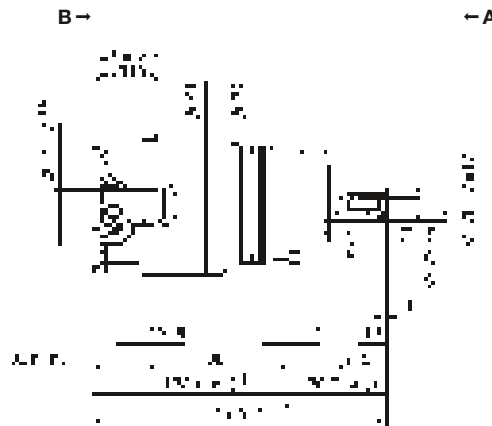
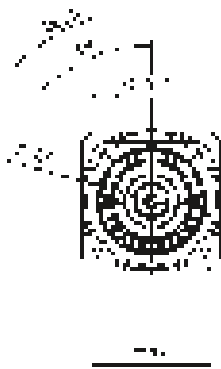

Planetary gearboxes

SP+

MC

Other output variants

Shaft with key



Splined shaft (DIN 5480)



Shaft mounted

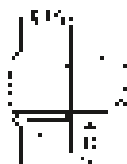

Non-tolerated dimensions are nominal dimensions

¹⁾ Check motor shaft fit

²⁾ Min./Max. permissible motor shaft length. Longer motor shafts are possible, please contact alpha.

³⁾ The dimensions depend on the motor

⁴⁾ Smaller motor shaft diameter is compensated by a bushing with a minimum thickness of 1 mm

⁵⁾ Standard clamping hub diameter

SP+ 100 MC 1-stage

			Standard version MC						Friction optimized version L							
Ratio	<i>i</i>		3	4	5	7	8	10	3	4	5	7	8	10		
Max. torque ^{a) b) e)}	T_{2a}	Nm	180	240	240	240	180	180	180	240	240	240	180	180		
		in.lb	1593	2124	2124	2124	1593	1593	1593	2124	2124	2124	1593	1593		
Max. acceleration torque ^{b) e)} (max. 1000 cycles per hour)	T_{2B}	Nm	180	240	240	240	180	180	180	240	240	240	180	180		
		in.lb	1593	2124	2124	2124	1593	1593	1593	2124	2124	2124	1593	1593		
Nominal torque (at n_n)	T_{2N}	Nm	76	95	91	93	93	97	76	95	91	93	93	97		
		in.lb	677	838	806	823	821	861	677	838	806	823	821	861		
Emergency stop torque ^{a) b) e)} (permitted 1000 times during the service life of the gearbox)	T_{2Not}	Nm	454	625	625	625	599	599	454	625	625	625	599	599		
		in.lb	4016	5532	5532	5532	5302	5302	4016	5532	5532	5532	5302	5302		
Permitted average input speed (at T_{2a} and 20 °C ambient temperature) ^{d)}	n_{1N}	rpm	3500	4000	4500	4500	4500	4500	3500	4000	4500	4500	4500	4500		
Max. input speed	n_{1Max}	rpm	6000	6000	6000	6000	6000	6000	6000	6000	6000	6000	6000	6000		
Mean no load running torque ^{b)} (at $n_1 = 3000$ rpm and 20 °C gearbox temperature)	T_{012}	Nm	2.0	1.8	1.4	0.84	0.78	0.64	0.9	0.8	0.6	0.5	0.4	0.4		
		in.lb	17	16	12	7.4	6.9	5.7	8.0	7.1	5.3	4.4	3.5	3.5		
Max. backlash	j_t	arcmin	Standard ≤ 4 / Reduced ≤ 2													
Torsional rigidity ^{b)}	C_{121}	Nm/arcmin	31													
		in.lb/arcmin	274													
Max. axial force ^{c)}	F_{2AMax}	N	5650					2000								
		lb _f	1271					450								
Max. lateral force ^{c)}	F_{2QMax}	N	6600					1000								
		lb _f	1485					225								
Max. tilting moment	M_{2KMax}	Nm	487					72								
		in.lb	4310					637								
Efficiency at full load	η	%	98.5					99								
Service life	L_h	h	> 30000													
Weight (incl. standard adapter plate)	m	kg	7.7													
		lb _m	17													
Operating noise (at reference ratio and reference speed – ratio-specific values available in cymex [®])	L_{pA}	dB(A)	≤ 58													
Max. permitted housing temperature		°C	+90													
		F	194													
Ambient temperature		°C	-15 to +40													
		F	5 to 104													
Lubrication			Lubricated for life													
Direction of rotation			In- and output same direction													
Protection class			IP 65					IP 52								
Metal bellows coupling (recommended product type – validate sizing with cymex [®])			BC2-00300AA032.000-X													
Bore diameter of coupling on the application side		mm	X = 024.000 - 060.000													
Mass moment of inertia (relates to the drive)	G	24	J_1	kgcm ²	3.99	3.04	2.61	2.29	2.26	2.07	3.99	3.04	2.61	2.29	2.26	2.07
				10 ⁻³ in.lb.s ²	3.53	2.69	2.31	2.03	2.00	1.83	3.53	2.69	2.31	2.03	2.00	1.83
Clamping hub diameter [mm]	K	38	J_1	kgcm ²	11.1	10.1	9.68	9.36	9.55	9.14	11.1	10.1	9.68	9.36	9.55	9.14
				10 ⁻³ in.lb.s ²	9.82	8.94	8.57	8.28	8.45	8.09	9.82	8.94	8.57	8.28	8.45	8.09

Please use our sizing software cymex[®] for a detailed sizing – www.wittenstein-cymex.com

^{a)} At max. 10 % F_{2QMax}

^{b)} Valid for standard clamping hub diameter

^{c)} Refers to center of the output shaft or flange

^{d)} Please reduce input speed at higher ambient temperatures

^{e)} Smooth shaft

View A

View B

1-stage

up to 24⁴⁾ (G)⁵⁾
clamping hub diameter

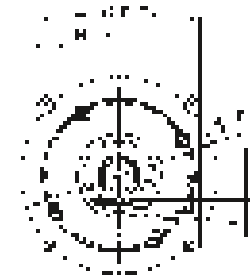
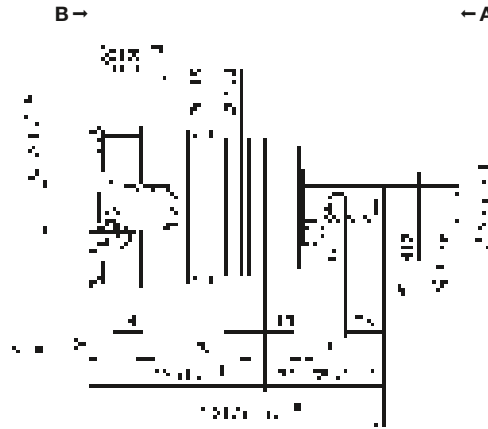
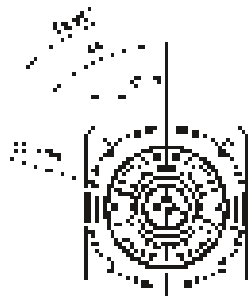

Motor shaft diameter [mm]

up to 38⁴⁾ (K)
clamping hub diameter

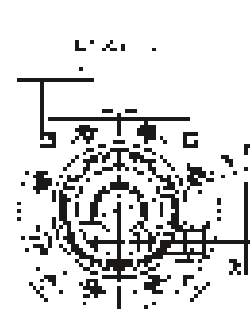
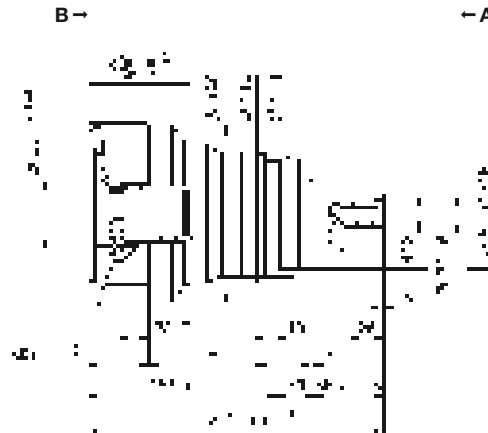
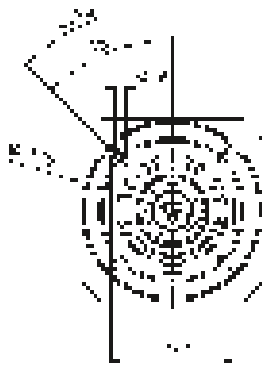

Planetary gearboxes

SP+

MC

Other output variants

Shaft with key

Splined shaft (DIN 5480)

Shaft mounted

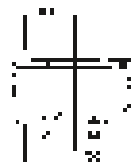

Non-tolerated dimensions are nominal dimensions

¹⁾ Check motor shaft fit

²⁾ Min./Max. permissible motor shaft length. Longer motor shafts are possible, please contact alpha.

³⁾ The dimensions depend on the motor

⁴⁾ Smaller motor shaft diameter is compensated by a bushing with a minimum thickness of 1 mm

⁵⁾ Standard clamping hub diameter

SP+ 100 MC 2-stage

			2-stage												
Ratio	<i>i</i>		16	20	25	28	32	35	40	50	64	70	100		
Max. torque ^{a) b) e)}	T_{2a}	<i>Nm</i>	240	240	240	240	240	240	240	240	180	240	180		
		<i>in.lb</i>	2124	2124	2124	2124	2124	2124	2124	2124	2124	1593	2124	1593	
Max. acceleration torque ^{b) e)} (max. 1000 cycles per hour)	T_{2B}	<i>Nm</i>	240	240	240	240	240	240	240	240	180	240	180		
		<i>in.lb</i>	2124	2124	2124	2124	2124	2124	2124	2124	2124	1593	2124	1593	
Nominal torque (at n_n)	T_{2N}	<i>Nm</i>	138	148	149	164	141	164	183	182	144	189	144		
		<i>in.lb</i>	1221	1313	1322	1453	1251	1450	1617	1614	1275	1673	1275		
Emergency stop torque ^{a) b) e)} (permitted 1000 times during the service life of the gearbox)	T_{2Not}	<i>Nm</i>	625	625	625	625	625	625	625	625	599	625	599		
		<i>in.lb</i>	5532	5532	5532	5532	5532	5532	5532	5532	5302	5532	5302		
Permitted average input speed (at T_{2a} and 20 °C ambient temperature) ^{d)}	n_{1N}	<i>rpm</i>	4500	4500	4500	4500	4500	4500	4500	4500	4500	4500	4500		
Max. input speed	n_{1Max}	<i>rpm</i>	6000	6000	6000	6000	6000	6000	6000	6000	6000	6000	6000		
Mean no load running torque ^{b)} (at $n_1 = 3000$ rpm and 20 °C gearbox temperature)	T_{012}	<i>Nm</i>	0.52	0.53	0.48	0.43	0.38	0.28	0.40	0.25	0.25	0.20	0.19		
		<i>in.lb</i>	4.6	4.7	4.2	3.8	3.4	2.5	3.5	2.2	2.2	1.8	1.7		
Max. backlash	j_t	<i>arcmin</i>	Standard ≤ 6 / Reduced ≤ 4												
Torsional rigidity ^{b)}	C_{121}	<i>Nm/arcmin</i>	31												
		<i>in.lb/arcmin</i>	274												
Max. axial force ^{c)}	F_{2AMax}	<i>N</i>	5650												
		<i>lb_f</i>	1271												
Max. lateral force ^{c)}	F_{2QMax}	<i>N</i>	6600												
		<i>lb_f</i>	1485												
Max. tilting moment	M_{2KMax}	<i>Nm</i>	487												
		<i>in.lb</i>	4310												
Efficiency at full load	η	%	96.5												
Service life	L_h	<i>h</i>	> 30000												
Weight (incl. standard adapter plate)	<i>m</i>	<i>kg</i>	7.9												
		<i>lb_m</i>	17.5												
Operating noise (at reference ratio and reference speed – ratio-specific values available in cymex [®])	L_{pA}	<i>dB(A)</i>	≤ 56												
Max. permitted housing temperature		°C	+90												
		<i>F</i>	194												
Ambient temperature		°C	-15 to +40												
		<i>F</i>	5 to 104												
Lubrication			Lubricated for life												
Direction of rotation			In- and output same direction												
Protection class			IP 65												
Metal bellows coupling (recommended product type – validate sizing with cymex [®])			BC2-00300AA032.000-X												
Bore diameter of coupling on the application side		<i>mm</i>	X = 024.000 - 060.000												
Mass moment of inertia (relates to the drive) Clamping hub diameter [mm]	E	19	J_1	<i>kgcm²</i>	0.81	0.70	0.68	0.60	0.43	0.59	0.55	0.54	0.38	0.54	0.54
				<i>10⁻³ in.lb.s²</i>	0.72	0.62	0.60	0.53	0.38	0.52	0.49	0.48	0.34	0.48	0.48
	G	24	J_1	<i>kgcm²</i>	2.18	2.07	2.05	1.97	2.06	1.96	1.92	1.91	1.91	1.91	1.91
				<i>10⁻³ in.lb.s²</i>	1.93	1.83	1.81	1.74	1.82	1.73	1.70	1.69	1.69	1.69	1.69

Please use our sizing software cymex[®] for a detailed sizing – www.wittenstein-cymex.com

^{a)} At max. 10 % F_{2QMax}

^{b)} Valid for standard clamping hub diameter

^{c)} Refers to center of the output shaft or flange

^{d)} Please reduce input speed at higher ambient temperatures

^{e)} Smooth shaft

View A

View B

2-stage

up to 19⁴⁾ (E)⁵⁾
clamping hub
diameter

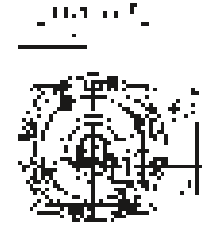
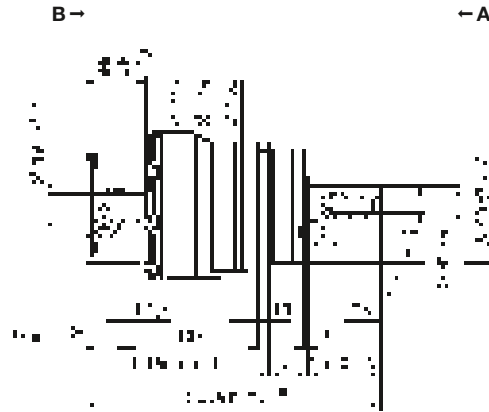
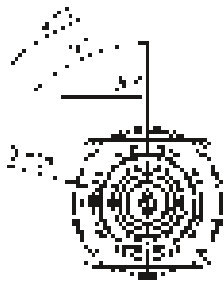

Motor shaft diameter [mm]

up to 24⁴⁾ (G)
clamping hub
diameter

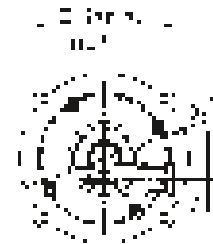
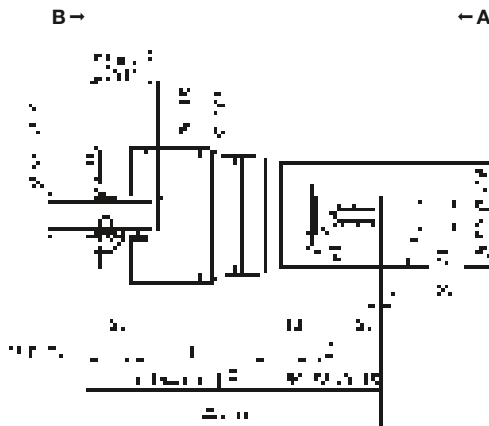
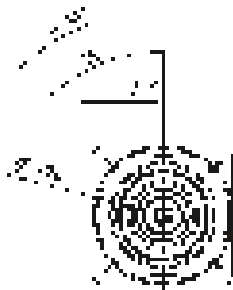

Planetary gearboxes

SP+

MC

Other output variants

Shaft with key



Splined shaft (DIN 5480)



Shaft mounted

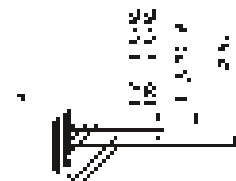

- Non-tolerated dimensions are nominal dimensions
- ¹⁾ Check motor shaft fit
- ²⁾ Min./Max. permissible motor shaft length. Longer motor shafts are possible, please contact alpha.
- ³⁾ The dimensions depend on the motor
- ⁴⁾ Smaller motor shaft diameter is compensated by a bushing with a minimum thickness of 1 mm
- ⁵⁾ Standard clamping hub diameter

SP+ 140 MC 1-stage

			Standard version MC						Friction optimized version L							
Ratio	<i>i</i>		3	4	5	7	8	10	3	4	5	7	8	10		
Max. torque ^{a) b) e)}	T_{2a}	Nm	310	480	480	480	380	380	310	480	480	480	380	380		
		in.lb	2744	4248	4248	4248	3363	3363	2744	4248	4248	4248	3363	3363		
Max. acceleration torque ^{b) e)} (max. 1000 cycles per hour)	T_{2B}	Nm	310	480	480	480	380	380	310	480	480	480	380	380		
		in.lb	2744	4248	4248	4248	3363	3363	2744	4248	4248	4248	3363	3363		
Nominal torque (at n_n)	T_{2N}	Nm	127	195	182	187	186	195	127	195	182	187	186	195		
		in.lb	1122	1730	1612	1656	1644	1727	1122	1730	1612	1656	1644	1727		
Emergency stop torque ^{a) b) e)} (permitted 1000 times during the service life of the gearbox)	T_{2Not}	Nm	1250	1350	1350	1350	1250	1250	1250	1350	1350	1350	1250	1250		
		in.lb	11064	11949	11949	11949	11064	11064	11064	11949	11949	11949	11064	11064		
Permitted average input speed (at T_{2a} and 20 °C ambient temperature) ^{d)}	n_{1N}	rpm	3000	3500	4500	4500	4500	4500	3000	3500	4500	4500	4500	4500		
Max. input speed	n_{1Max}	rpm	6000	6000	6000	6000	6000	6000	6000	6000	6000	6000	6000	6000		
Mean no load running torque ^{b)} (at $n_1 = 3000$ rpm and 20 °C gearbox temperature)	T_{012}	Nm	4.1	3.5	2.8	2.2	1.8	1.7	2.0	1.5	1.2	1.0	0.9	0.9		
		in.lb	36	31	25	20	16	15	18	13	11	8.9	8.0	8.0		
Max. backlash	j_t	arcmin	Standard ≤ 4 / Reduced ≤ 2													
Torsional rigidity ^{b)}	C_{121}	Nm/arcmin	53													
		in.lb/arcmin	469													
Max. axial force ^{c)}	F_{2AMax}	N	9870						3000							
		lb _f	2221						675							
Max. lateral force ^{c)}	F_{2QMax}	N	9900						1200							
		lb _f	2228						270							
Max. tilting moment	M_{2KMax}	Nm	952						110							
		in.lb	8426						974							
Efficiency at full load	η	%	98.5						99							
Service life	L_h	h	> 30000													
Weight (incl. standard adapter plate)	m	kg	17.2													
		lb _m	38													
Operating noise (at reference ratio and reference speed – ratio-specific values available in cymex [®])	L_{pA}	dB(A)	≤ 59													
Max. permitted housing temperature		°C	+90													
		F	194													
Ambient temperature		°C	-15 to +40													
		F	5 to 104													
Lubrication			Lubricated for life													
Direction of rotation			In- and output same direction													
Protection class			IP 65						IP 52							
Metal bellows coupling (recommended product type – validate sizing with cymex [®])			BC2-00500AA040.000-X													
Bore diameter of coupling on the application side		mm	X = 035.000 - 060.000													
Mass moment of inertia (relates to the drive) Clamping hub diameter [mm]	K	38	J_1	kgcm ²	14.9	12.1	11.0	10.1	10.1	9.5	14.9	12.1	11.0	10.1	10.1	9.5
				10 ⁻³ in.lb.s ²	13.2	10.7	9.7	8.9	8.9	8.4	13.2	10.7	9.7	8.9	8.9	8.4
	M	48	J_1	kgcm ²	29.5	26.7	25.6	24.7	24.7	24.2	29.5	26.7	25.6	24.7	24.7	24.2
				10 ⁻³ in.lb.s ²	26.1	23.6	22.7	21.9	21.9	21.4	26.1	23.6	22.7	21.9	21.9	21.4

Please use our sizing software cymex[®] for a detailed sizing – www.wittenstein-cymex.com

- ^{a)} At max. 10 % F_{2QMax}
- ^{b)} Valid for standard clamping hub diameter
- ^{c)} Refers to center of the output shaft or flange
- ^{d)} Please reduce input speed at higher ambient temperatures
- ^{e)} Smooth shaft

View A

View B

1-stage

up to 38⁴⁾ (K)⁵⁾
clamping hub diameter

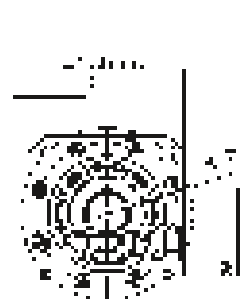
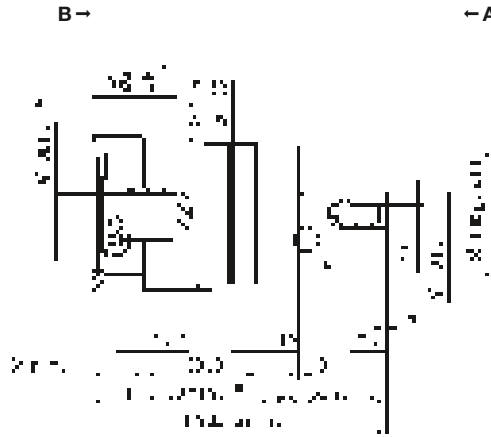
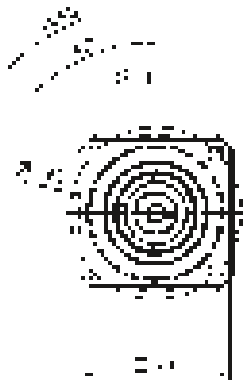

Motor shaft diameter [mm]

up to 48⁴⁾ (M)
clamping hub diameter

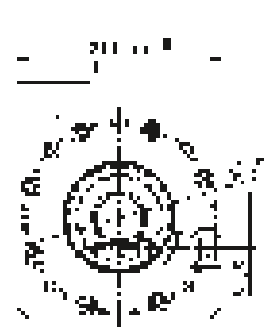
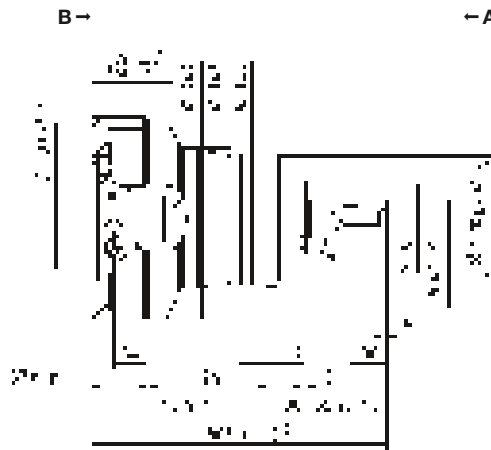
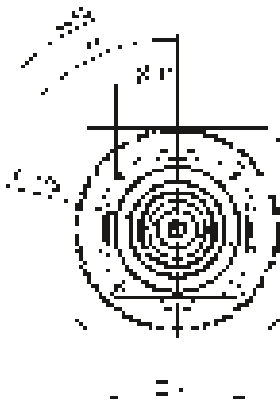

Planetary gearboxes

SP+

MC

Other output variants

Shaft with key

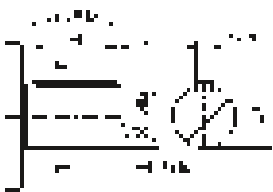

Splined shaft (DIN 5480)



Shaft mounted

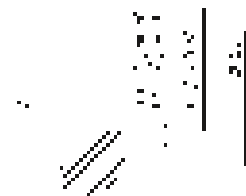

Non-tolerated dimensions are nominal dimensions

¹⁾ Check motor shaft fit

²⁾ Min./Max. permissible motor shaft length. Longer motor shafts are possible, please contact alpha.

³⁾ The dimensions depend on the motor

⁴⁾ Smaller motor shaft diameter is compensated by a bushing with a minimum thickness of 1 mm

⁵⁾ Standard clamping hub diameter

SP+ 140 MC 2-stage

			2-stage												
Ratio	<i>i</i>		16	20	25	28	32	35	40	50	64	70	100		
Max. torque ^{a) b) e)}	T_{2a}	Nm	480	480	480	480	480	480	480	480	380	480	380		
		in.lb	4248	4248	4248	4248	4248	4248	4248	4248	4248	3363	4248	3363	
Max. acceleration torque ^{b) e)} (max. 1000 cycles per hour)	T_{2B}	Nm	480	480	480	480	480	480	480	480	380	480	380		
		in.lb	4248	4248	4248	4248	4248	4248	4248	4248	4248	3363	4248	3363	
Nominal torque (at n_N)	T_{2N}	Nm	277	297	298	328	287	329	364	367	304	304	304		
		in.lb	2447	2629	2636	2900	2544	2915	3219	3250	2691	2690	2691		
Emergency stop torque ^{a) b) e)} (permitted 1000 times during the service life of the gearbox)	T_{2Not}	Nm	1350	1350	1350	1350	1350	1350	1350	1350	1250	1350	1250		
		in.lb	11949	11949	11949	11949	11949	11949	11949	11949	11064	11949	11064		
Permitted average input speed (at T_{2a} and 20 °C ambient temperature) ^{d)}	n_{1N}	rpm	4500	4500	4500	4500	4500	4500	4500	4500	4500	4500	4500		
Max. input speed	n_{1Max}	rpm	6000	6000	6000	6000	6000	6000	6000	6000	6000	6000	6000		
Mean no load running torque ^{b)} (at $n_1 = 3000$ rpm and 20 °C gearbox temperature)	T_{012}	Nm	1.1	1.0	0.96	0.80	0.72	0.60	0.55	0.45	0.45	0.40	0.40		
		in.lb	9.7	9.2	8.5	7.1	6.4	5.3	4.9	4.0	4.0	3.5	3.5		
Max. backlash	j_t	arcmin	Standard ≤ 6 / Reduced ≤ 4												
Torsional rigidity ^{b)}	C_{121}	Nm/arcmin	53												
		in.lb/arcmin	469												
Max. axial force ^{c)}	F_{2AMax}	N	9870												
		lb _f	2221												
Max. lateral force ^{c)}	F_{2QMax}	N	9900												
		lb _f	2228												
Max. tilting moment	M_{2KMax}	Nm	952												
		in.lb	8426												
Efficiency at full load	η	%	96.5												
Service life	L_h	h	> 30000												
Weight (incl. standard adapter plate)	m	kg	17												
		lb _m	37.6												
Operating noise (at reference ratio and reference speed – ratio-specific values available in cymex [®])	L_{pA}	dB(A)	≤ 59												
Max. permitted housing temperature		°C	+90												
		F	194												
Ambient temperature		°C	-15 to +40												
		F	5 to 104												
Lubrication			Lubricated for life												
Direction of rotation			In- and output same direction												
Protection class			IP 65												
Metal bellows coupling (recommended product type – validate sizing with cymex [®])			BC2-00500AA040.000-X												
Bore diameter of coupling on the application side		mm	X = 035.000 - 060.000												
Mass moment of inertia (relates to the drive) Clamping hub diameter [mm]	G	24	J_1	kgcm ²	3.19	2.71	2.67	2.34	1.65	2.32	2.10	2.08	2.08	2.08	2.07
				10 ⁻³ in.lb.s ²	2.82	2.40	2.36	2.07	1.46	2.05	1.86	1.84	1.84	1.84	1.83
	K	38	J_1	kgcm ²	10.3	9.77	9.73	9.41	2.34	9.39	9.16	9.15	1.39	9.14	9.14
				10 ⁻³ in.lb.s ²	9.07	8.65	8.61	8.33	2.07	8.31	8.11	8.10	1.23	8.09	8.09

Please use our sizing software cymex[®] for a detailed sizing – www.wittenstein-cymex.com

^{a)} At max. 10 % F_{2QMax}

^{b)} Valid for standard clamping hub diameter

^{c)} Refers to center of the output shaft or flange

^{d)} Please reduce input speed at higher ambient temperatures

^{e)} Smooth shaft

View A

View B

2-stage

up to 24⁴⁾ (G)⁵⁾
clamping hub diameter

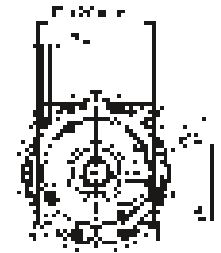
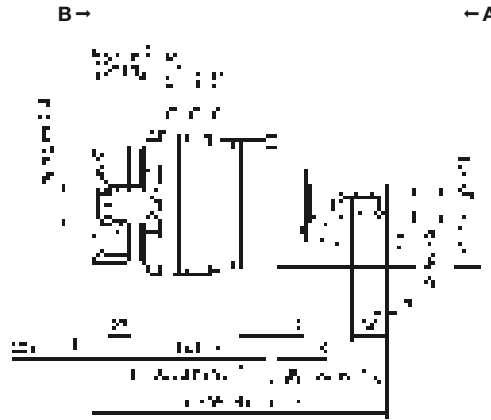
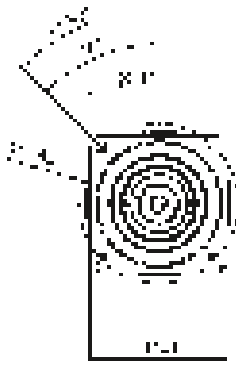

Motor shaft diameter [mm]

up to 38⁴⁾ (K)
clamping hub diameter

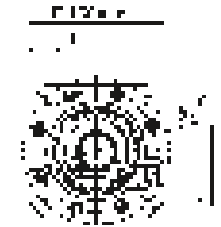
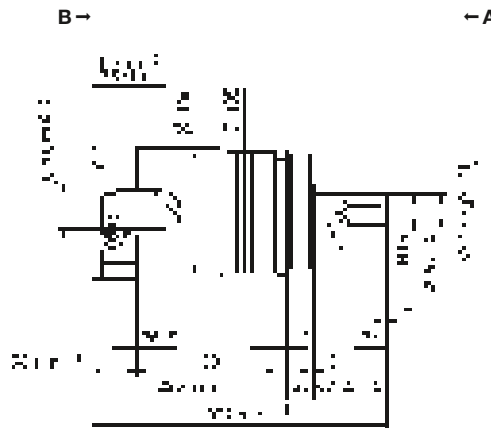
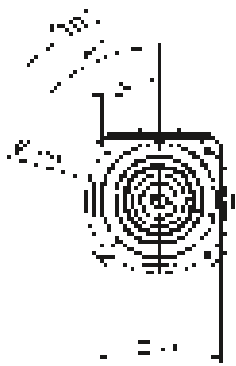

Planetary gearboxes

SP+

MC

Other output variants

Shaft with key

Splined shaft (DIN 5480)

Shaft mounted

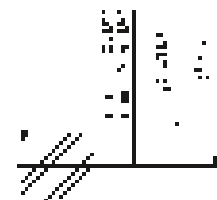
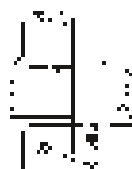
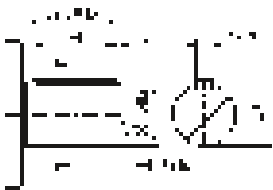

Non-tolerated dimensions are nominal dimensions

¹⁾ Check motor shaft fit

²⁾ Min./Max. permissible motor shaft length. Longer motor shafts are possible, please contact alpha.

³⁾ The dimensions depend on the motor

⁴⁾ Smaller motor shaft diameter is compensated by a bushing with a minimum thickness of 1 mm

⁵⁾ Standard clamping hub diameter

SP+ 180 MC 1-stage

			Standard version MC						Friction optimized version L						
Ratio	<i>i</i>		3	4	5	7	8	10	3	4	5	7	8	10	
Max. torque ^{a) b) e)}	T_{2a}	Nm	700	880	880	880	700	700	700	880	880	880	700	700	
		in.lb	6196	7789	7789	7789	6196	6196	6196	7789	7789	7789	6196	6196	
Max. acceleration torque ^{b) e)} (max. 1000 cycles per hour)	T_{2B}	Nm	700	880	880	880	700	700	700	880	880	880	700	700	
		in.lb	6196	7789	7789	7789	6196	6196	6196	7789	7789	7789	6196	6196	
Nominal torque (at n_{1N})	T_{2N}	Nm	289	492	379	469	465	488	289	492	379	469	465	488	
		in.lb	2554	4355	3357	4151	4117	4316	2554	4355	3357	4151	4117	4316	
Emergency stop torque ^{a) b) e)} (permitted 1000 times during the service life of the gearbox)	T_{2Not}	Nm	2640	2750	2750	2750	2640	2640	2640	2750	2750	2750	2640	2640	
		in.lb	23366	24340	24340	24340	23366	23366	23366	24340	24340	24340	23366	23366	
Permitted average input speed (at T_{2a} and 20 °C ambient temperature) ^{d)}	n_{1N}	rpm	3000	3500	4500	4500	4500	4500	3000	3500	4500	4500	4500	4500	
Max. input speed	n_{1Max}	rpm	4500	6000	6000	6000	6000	6000	4500	6000	6000	6000	6000	6000	
Mean no load running torque ^{b)} (at $n_1 = 3000$ rpm and 20 °C gearbox temperature)	T_{012}	Nm	8.8	7.4	6.0	4.4	4.4	3.2	3.8	3.0	2.3	1.8	1.7	1.6	
		in.lb	78	66	53	39	39	28	34	27	20	16	15	14	
Max. backlash	j_t	arcmin	Standard ≤ 4 / Reduced ≤ 2												
Torsional rigidity ^{b)}	C_{121}	Nm/arcmin	175												
		in.lb/arcmin	1549												
Max. axial force ^{c)}	F_{2AMax}	N	14150					5000							
		lb _f	3184					1125							
Max. lateral force ^{c)}	F_{2QMax}	N	15400					2000							
		lb _f	3465					450							
Max. tilting moment	M_{2KMax}	Nm	1600					208							
		in.lb	14161					1841							
Efficiency at full load	η	%	98.5					99							
Service life	L_h	h	> 30000												
Weight (incl. standard adapter plate)	m	kg	34												
		lb _m	75.1												
Operating noise (at reference ratio and reference speed – ratio-specific values available in cymex [®])	L_{pA}	dB(A)	≤ 62												
Max. permitted housing temperature		°C	+90												
		F	194												
Ambient temperature		°C	-15 to +40												
		F	5 to 104												
Lubrication			Lubricated for life												
Direction of rotation			In- and output same direction												
Protection class			IP 65					IP 52							
Metal bellows coupling (recommended product type – validate sizing with cymex [®])			BC2-00800AA055.000-X												
Bore diameter of coupling on the application side		mm	X = 040.000 - 075.000												
Mass moment of inertia (relates to the drive) Clamping hub diameter [mm]	M 48	J_1	kgcm ²	58.5	41.6	35.6	30.0	30.0	26.9	58.5	41.6	35.6	30.0	30.0	26.9
			10 ⁻³ in.lb.s ²	51.8	36.8	31.5	26.6	26.6	23.8	51.8	36.8	31.5	26.6	26.6	23.8

Please use our sizing software cymex[®] for a detailed sizing – www.wittenstein-cymex.com

- ^{a)} At max. 10 % F_{2QMax}
- ^{b)} Valid for standard clamping hub diameter
- ^{c)} Refers to center of the output shaft or flange
- ^{d)} Please reduce input speed at higher ambient temperatures
- ^{e)} Smooth shaft

View A

View B

Motor shaft diameter [mm]

1-stage

up to 48⁴⁾ (M)⁵⁾
clamping hub diameter

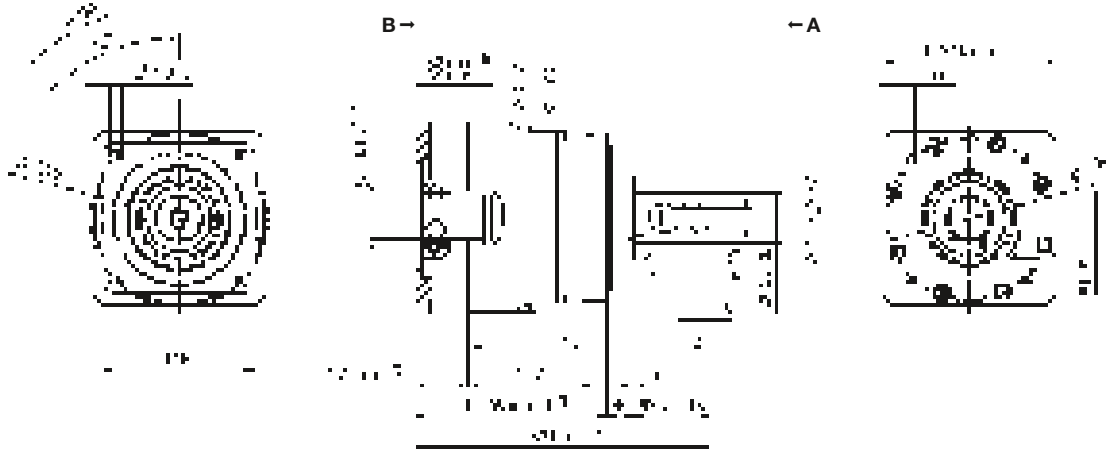

Planetary gearboxes

SP+

MC

Other output variants

Shaft with key

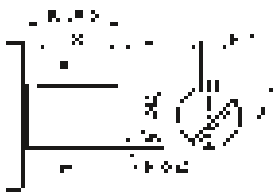

Splined shaft (DIN 5480)

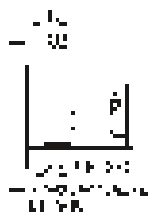

Shaft mounted

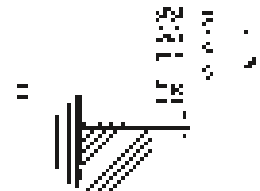
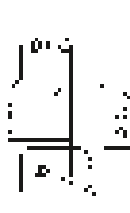

Non-tolerated dimensions are nominal dimensions

¹⁾ Check motor shaft fit

²⁾ Min./Max. permissible motor shaft length. Longer motor shafts are possible, please contact alpha.

³⁾ The dimensions depend on the motor

⁴⁾ Smaller motor shaft diameter is compensated by a bushing with a minimum thickness of 1 mm

⁵⁾ Standard clamping hub diameter

SP+ 180 MC 2-stage

				2-stage											
Ratio	<i>i</i>			16	20	25	28	32	35	40	50	64	70	100	
Max. torque ^{a) b) e)}	T_{2a}	<i>Nm</i>		880	880	880	880	880	880	880	880	700	880	700	
		<i>in.lb</i>		7789	7789	7789	7789	7789	7789	7789	7789	7789	6196	7789	6196
Max. acceleration torque ^{b) e)} (max. 1000 cycles per hour)	T_{2B}	<i>Nm</i>		880	880	880	880	880	880	880	880	700	880	700	
		<i>in.lb</i>		7789	7789	7789	7789	7789	7789	7789	7789	7789	6196	7789	6196
Nominal torque (at n_{1N})	T_{2N}	<i>Nm</i>		696	704	704	704	704	704	704	704	560	704	560	
		<i>in.lb</i>		6156	6231	6231	6231	6231	6231	6231	6231	6231	4956	6231	4956
Emergency stop torque ^{a) b) e)} (permitted 1000 times during the service life of the gearbox)	T_{2Not}	<i>Nm</i>		2750	2750	2750	2750	2750	2750	2750	2750	2640	2750	2640	
		<i>in.lb</i>		24340	24340	24340	24340	24340	24340	24340	24340	24340	23366	24340	23366
Permitted average input speed (at T_{2a} and 20 °C ambient temperature) ^{d)}	n_{1N}	<i>rpm</i>		4500	4500	4500	4500	4500	4500	4500	4500	4500	4500	4500	
Max. input speed	n_{1Max}	<i>rpm</i>		6000	6000	6000	6000	6000	6000	6000	6000	6000	6000	6000	
Mean no load running torque ^{b)} (at $n_1 = 3000$ rpm and 20 °C gearbox temperature)	T_{012}	<i>Nm</i>		2.2	2.3	1.8	1.7	1.7	1.4	1.2	1.2	1.2	0.95	1.0	
		<i>in.lb</i>		20	21	16	15	15	12	11	11	11	8.4	9.2	
Max. backlash	j_t	<i>arcmin</i>		Standard ≤ 6 / Reduced ≤ 4											
Torsional rigidity ^{b)}	C_{121}	<i>Nm/arcmin</i>		175											
		<i>in.lb/arcmin</i>		1549											
Max. axial force ^{c)}	F_{2AMax}	<i>N</i>		14150											
		<i>lb_f</i>		3184											
Max. lateral force ^{c)}	F_{2QMax}	<i>N</i>		15400											
		<i>lb_f</i>		3465											
Max. tilting moment	M_{2KMax}	<i>Nm</i>		1600											
		<i>in.lb</i>		14161											
Efficiency at full load	η	%		96.5											
Service life	L_h	<i>h</i>		> 30000											
Weight (incl. standard adapter plate)	m	<i>kg</i>		36											
		<i>lb_m</i>		79.6											
Operating noise (at reference ratio and reference speed – ratio-specific values available in cymex [®])	L_{pA}	<i>dB(A)</i>		≤ 58											
Max. permitted housing temperature		°C		+90											
		<i>F</i>		194											
Ambient temperature		°C		-15 to +40											
		<i>F</i>		5 to 104											
Lubrication				Lubricated for life											
Direction of rotation				In- and output same direction											
Protection class				IP 65											
Metal bellows coupling (recommended product type – validate sizing with cymex [®])				BC2-00800AA055.000-X											
Bore diameter of coupling on the application side		<i>mm</i>		X = 040.000 - 075.000											
Mass moment of inertia (relates to the drive) Clamping hub diameter [mm]	K	38	J_1	<i>kgcm²</i>	13.5	12.0	11.7	10.6	10.6	10.4	9.74	9.68	5.45	9.63	9.60
				<i>10⁻³ in.lb.s²</i>	12.0	10.6	10.4	9.34	9.34	9.23	8.62	8.57	4.82	8.52	8.50

Please use our sizing software cymex[®] for a detailed sizing – www.wittenstein-cymex.com

- ^{a)} At max. 10 % F_{2QMax}
- ^{b)} Valid for standard clamping hub diameter
- ^{c)} Refers to center of the output shaft or flange
- ^{d)} Please reduce input speed at higher ambient temperatures
- ^{e)} Smooth shaft

View A

View B

Motor shaft diameter [mm]

2-stage

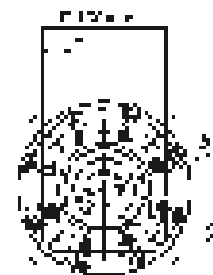
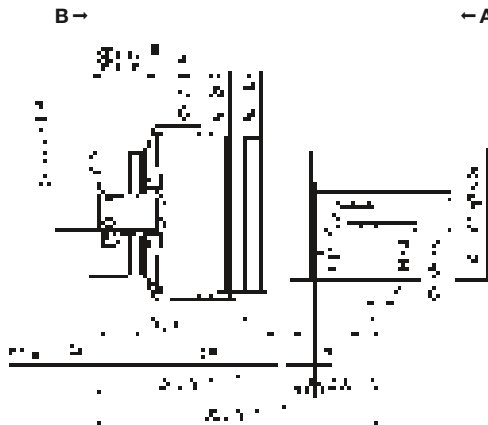
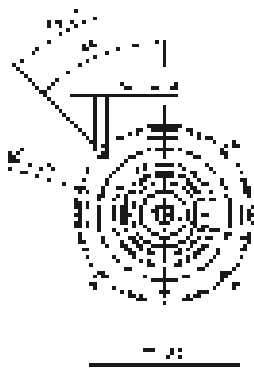
 up to 38⁴⁾ (K)⁵⁾
 clamping hub diameter

Planetary gearboxes

SP+

MC

Other output variants

Shaft with key

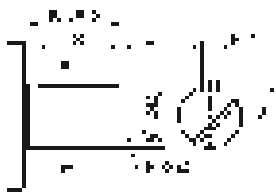

Splined shaft (DIN 5480)

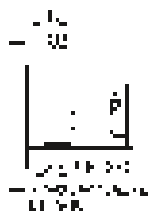

Shaft mounted

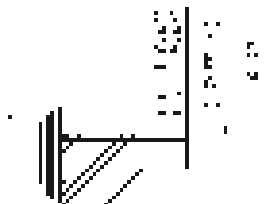
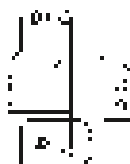

- Non-tolerated dimensions are nominal dimensions
- ¹⁾ Check motor shaft fit
- ²⁾ Min./Max. permissible motor shaft length. Longer motor shafts are possible, please contact alpha.
- ³⁾ The dimensions depend on the motor
- ⁴⁾ Smaller motor shaft diameter is compensated by a bushing with a minimum thickness of 1 mm
- ⁵⁾ Standard clamping hub diameter

SP+ 210 MC 1-stage

			Standard version MC						Friction optimized version L							
Ratio	<i>i</i>		3	4	5	7	8	10	3	4	5	7	8	10		
Max. torque ^{a) b) e)}	T_{2a}	Nm	1200	2000	2000	1700	1200	1200	1200	2000	2000	1700	1200	1200		
		in.lb	10621	17702	17702	15046	10621	10621	10621	17702	17702	15046	10621	10621		
Max. acceleration torque ^{b) e)} (max. 1000 cycles per hour)	T_{2B}	Nm	1200	2000	2000	1700	1200	1200	1200	2000	2000	1700	1200	1200		
		in.lb	10621	17702	17702	15046	10621	10621	10621	17702	17702	15046	10621	10621		
Nominal torque (at n_n)	T_{2N}	Nm	960	1260	1141	1169	960	960	960	1260	1141	1169	960	960		
		in.lb	8497	11148	10098	10347	8497	8497	8497	11148	10098	10347	8497	8497		
Emergency stop torque ^{a) b) e)} (permitted 1000 times during the service life of the gearbox)	T_{2Not}	Nm	5900	5900	5900	5900	5900	5900	5900	5900	5900	5900	5900	5900		
		in.lb	52220	52220	52220	52220	52220	52220	52220	52220	52220	52220	52220	52220		
Permitted average input speed (at T_{2a} and 20 °C ambient temperature) ^{d)}	n_{1N}	rpm	2250	2500	3500	3500	3500	3500	2250	2500	3500	3500	3500			
Max. input speed	n_{1Max}	rpm	3400	6000	6000	6000	6000	6000	3400	6000	6000	6000	6000			
Mean no load running torque ^{b)} (at $n_i = 2000$ rpm and 20 °C gearbox temperature)	T_{012}	Nm	12	11	8.4	5.6	5.6	3.6	5.5	4.9	4.6	4.0	3.8	3.6		
		in.lb	108	99	74	50	50	32	49	43	41	35	34	32		
Max. backlash	j_t	arcmin	Standard ≤ 4 / Reduced ≤ 2													
Torsional rigidity ^{b)}	C_{121}	Nm/arcmin	400													
		in.lb/arcmin	3540													
Max. axial force ^{c)}	F_{2AMax}	N	30000					8000								
		lb _f	6750					1800								
Max. lateral force ^{c)}	F_{2QMax}	N	21000					2500								
		lb _f	4725					563								
Max. tilting moment	M_{2KMax}	Nm	3100					310								
		in.lb	27437					2744								
Efficiency at full load	η	%	98.5					99								
Service life	L_h	h	> 30000													
Weight (incl. standard adapter plate)	m	kg	58													
		lb _m	128.2													
Operating noise (at reference ratio and reference speed – ratio-specific values available in cymex [®])	L_{pA}	dB(A)	≤ 64													
Max. permitted housing temperature		°C	+90													
		F	194													
Ambient temperature		°C	-15 to +40													
		F	5 to 104													
Lubrication			Lubricated for life													
Direction of rotation			In- and output same direction													
Protection class			IP 65					IP 52								
Metal bellows coupling (recommended product type – validate sizing with cymex [®])			BC2-04000AA075.000-X													
Bore diameter of coupling on the application side		mm	X = 050.000 - 090.000													
Mass moment of inertia (relates to the drive) Clamping hub diameter [mm]	N	55	J_t	kgcm ²	139	94.3	76.9	61.5	61.5	53.1	139	94.3	76.9	61.5	61.5	53.1
				10 ⁻³ in.lb.s ²	123	83.5	68.1	54.4	54.4	47.0	123	83.5	68.1	54.4	54.4	47.0

Please use our sizing software cymex[®] for a detailed sizing – www.wittenstein-cymex.com

^{a)} At max. 10 % F_{2QMax}

^{b)} Valid for standard clamping hub diameter

^{c)} Refers to center of the output shaft or flange

^{d)} Please reduce input speed at higher ambient temperatures

^{e)} Smooth shaft

View A

View B

Motor shaft diameter [mm]

1-stage

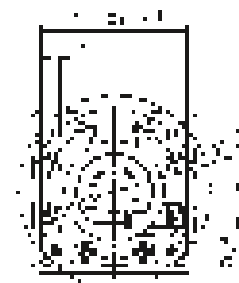
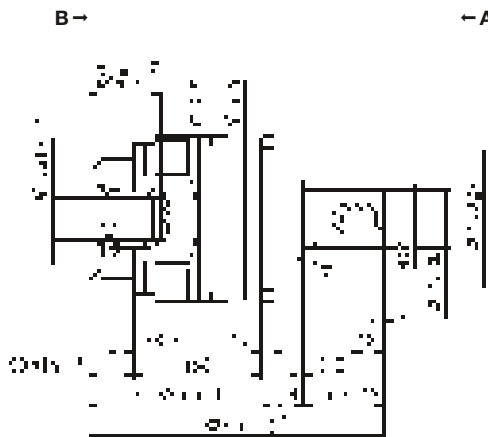
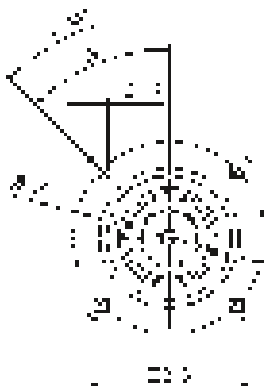
 up to 55⁴⁾ (N)⁵⁾
 clamping hub diameter

Planetary gearboxes

SP+

MC

Other output variants

Shaft with key

Splined shaft (DIN 5480)

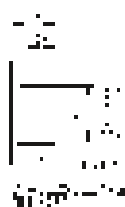
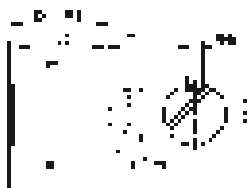

Non-tolerated dimensions are nominal dimensions

¹⁾ Check motor shaft fit

²⁾ Min./Max. permissible motor shaft length. Longer motor shafts are possible, please contact alpha.

³⁾ The dimensions depend on the motor

⁴⁾ Smaller motor shaft diameter is compensated by a bushing with a minimum thickness of 1 mm

⁵⁾ Standard clamping hub diameter

SP+ 210 MC 2-stage

				2-stage										
Ratio	<i>i</i>			16	20	25	28	32	35	40	50	64	70	100
Max. torque ^{a) b) e)}	T_{2a}	<i>Nm</i>		1680	1800	2000	1680	1680	1920	1040	1300	1200	1700	1200
		<i>in.lb</i>		14869	15931	17702	14869	14869	16994	9205	11506	10621	15046	10621
Max. acceleration torque ^{b) e)} (max. 1000 cycles per hour)	T_{2B}	<i>Nm</i>		1680	1800	2000	1680	1680	1920	1040	1300	1200	1700	1200
		<i>in.lb</i>		14869	15931	17702	14869	14869	16994	9205	11506	10621	15046	10621
Nominal torque (at n_n)	T_{2N}	<i>Nm</i>		898	728	910	744	1344	929	787	984	960	1360	960
		<i>in.lb</i>		7949	6445	8056	6581	11895	8226	6969	8711	8497	12037	8497
Emergency stop torque ^{a) b) e)} (permitted 1000 times during the service life of the gearbox)	T_{2Not}	<i>Nm</i>		5900	5900	5900	5900	5900	5900	5900	5900	5900	5900	5900
		<i>in.lb</i>		52220	52220	52220	52220	52220	52220	52220	52220	52220	52220	52220
Permitted average input speed (at T_{2a} and 20 °C ambient temperature) ^{d)}	n_{1N}	<i>rpm</i>		3500	4500	4500	4500	4500	4500	4500	4500	4500	4500	4500
Max. input speed	n_{1Max}	<i>rpm</i>		6000	6000	6000	6000	6000	6000	6000	6000	6000	6000	6000
Mean no load running torque ^{b)} (at $n_1 = 2000$ rpm and 20 °C gearbox temperature)	T_{012}	<i>Nm</i>		3.4	3.1	2.9	2.6	2.6	2.0	2.0	1.8	1.8	1.6	1.6
		<i>in.lb</i>		30	27	25	23	23	18	18	16	16	14	14
Max. backlash	j_t	<i>arcmin</i>		Standard ≤ 5 / Reduced ≤ 4										
Torsional rigidity ^{b)}	C_{121}	<i>Nm/arcmin</i>		400										
		<i>in.lb/arcmin</i>		3540										
Max. axial force ^{c)}	F_{2AMax}	<i>N</i>		30000										
		<i>lb_f</i>		6750										
Max. lateral force ^{c)}	F_{2QMax}	<i>N</i>		21000										
		<i>lb_f</i>		4725										
Max. tilting moment	M_{2KMax}	<i>Nm</i>		3100										
		<i>in.lb</i>		27437										
Efficiency at full load	η	%		96.5										
Service life	L_h	<i>h</i>		> 30000										
Weight (incl. standard adapter plate)	<i>m</i>	<i>kg</i>		53										
		<i>lb_m</i>		117.1										
Operating noise (at reference ratio and reference speed – ratio-specific values available in cymex [®])	L_{pA}	<i>dB(A)</i>		≤ 57										
Max. permitted housing temperature		°C		+90										
		<i>F</i>		194										
Ambient temperature		°C		-15 to +40										
		<i>F</i>		5 to 104										
Lubrication				Lubricated for life										
Direction of rotation				In- and output same direction										
Protection class				IP 65										
Metal bellows coupling (recommended product type – validate sizing with cymex [®])				BC2-04000AA075.000-X										
Bore diameter of coupling on the application side		<i>mm</i>		X = 050.000 - 090.000										
Mass moment of inertia (relates to the drive) Clamping hub diameter [mm]	M 48	J_1	<i>kgcm²</i>	34.5	31.5	30.8	30.0	30.0	29.7	28.5	28.3	28.3	28.1	28.0
			<i>10⁻³ in.lb.s²</i>	30.5	27.9	27.3	26.6	26.6	26.3	25.2	25.0	25.0	24.9	24.8

Please use our sizing software cymex[®] for a detailed sizing – www.wittenstein-cymex.com

- ^{a)} At max. 10 % F_{2QMax}
- ^{b)} Valid for standard clamping hub diameter
- ^{c)} Refers to center of the output shaft or flange
- ^{d)} Please reduce input speed at higher ambient temperatures
- ^{e)} Smooth shaft

View A

View B

Motor shaft diameter [mm]

2-stage

up to 48⁴⁾ (M)⁵⁾
clamping hub diameter

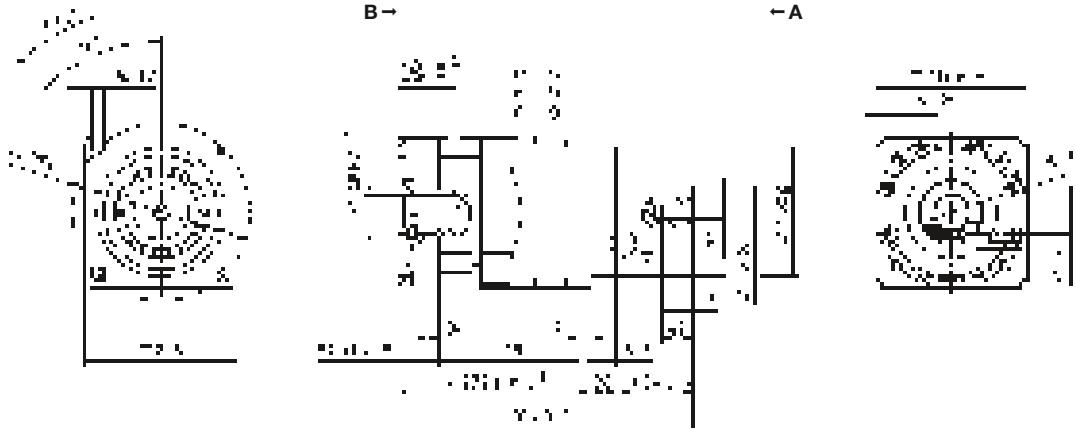

Planetary gearboxes

SP+

MC

Other output variants

Shaft with key

Splined shaft (DIN 5480)

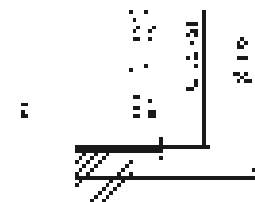
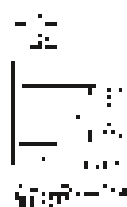
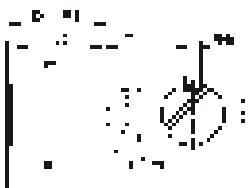

Non-tolerated dimensions are nominal dimensions

¹⁾ Check motor shaft fit

²⁾ Min./Max. permissible motor shaft length. Longer motor shafts are possible, please contact alpha.

³⁾ The dimensions depend on the motor

⁴⁾ Smaller motor shaft diameter is compensated by a bushing with a minimum thickness of 1 mm

⁵⁾ Standard clamping hub diameter

SP+ 240 MC 1-stage

			Standard version MC						Friction optimized version L						
Ratio	<i>i</i>		3	4	5	7	8	10	3	4	5	7	8	10	
Max. torque ^{a) b) e)}	T_{2a}	Nm	1750	3500	3600	2700	1800	1800	1750	3500	3600	2700	1800	1800	
		in.lb	15489	30978	31863	23897	15931	15931	15489	30978	31863	23897	15931	15931	
Max. acceleration torque ^{b) e)} (max. 1000 cycles per hour)	T_{2B}	Nm	1750	3500	3600	2700	1800	1800	1750	3500	3600	2700	1800	1800	
		in.lb	15489	30978	31863	23897	15931	15931	15489	30978	31863	23897	15931	15931	
Nominal torque (at n_{2N})	T_{2N}	Nm	1400	2029	1861	1910	1440	1440	1400	2029	1861	1910	1440	1440	
		in.lb	12391	17955	16471	16909	12745	12745	12391	17955	16471	16909	12745	12745	
Emergency stop torque ^{a) b) e)} (permitted 1000 times during the service life of the gearbox)	T_{2Not}	Nm	6850	8500	8500	8500	6850	6850	6850	8500	8500	8500	6850	6850	
		in.lb	60628	75232	75232	75232	60628	60628	60628	75232	75232	75232	60628	60628	
Permitted average input speed (at T_{2a} and 20 °C ambient temperature) ^{d)}	n_{1N}	rpm	1750	2250	3000	3000	3000	3000	1750	2250	3000	3000	3000	3000	
Max. input speed	n_{1Max}	rpm	3400	4000	5000	5000	5000	5000	3400	4000	5000	5000	5000	5000	
Mean no load running torque ^{b)} (at $n_1 = 2000$ rpm and 20 °C gearbox temperature)	T_{012}	Nm	18	16	12	8.6	8.6	5.8	8.0	7.0	6.0	5.0	4.8	4.2	
		in.lb	159	141	107	77	77	51	71	62	53	44	43	37	
Max. backlash	j_t	arcmin	Standard ≤ 4 / Reduced ≤ 2												
Torsional rigidity ^{b)}	C_{121}	Nm/arcmin	550												
		in.lb/arcmin	4868												
Max. axial force ^{c)}	F_{2AMax}	N	33000						10000						
		lb _f	7425						2250						
Max. lateral force ^{c)}	F_{2QMax}	N	30000						2000						
		lb _f	6750						450						
Max. tilting moment	M_{2KMax}	Nm	5000						280						
		in.lb	44254						2478						
Efficiency at full load	η	%	98.5						99						
Service life	L_h	h	> 30000												
Weight (incl. standard adapter plate)	m	kg	83												
		lb _m	183.4												
Operating noise (at reference ratio and reference speed – ratio-specific values available in cymex [®])	L_{pA}	dB(A)	≤ 66												
Max. permitted housing temperature		°C	+90												
		F	194												
Ambient temperature		°C	-15 to +40												
		F	5 to 104												
Lubrication			Lubricated for life												
Direction of rotation			In- and output same direction												
Protection class			IP 65						IP 52						
Metal bellows coupling (recommended product type – validate sizing with cymex [®])			BC2-04000AA085.000-X												
Bore diameter of coupling on the application side		mm	X = 050.000 - 090.000												
Mass moment of inertia (relates to the drive) Clamping hub diameter [mm]	O 60	J_1	kgcm ²	260	198	163	138	138	125	260	198	163	138	138	125
			10 ⁻³ in.lb.s ²	230	175	144	122	122	110	230	175	144	122	122	110

Please use our sizing software cymex[®] for a detailed sizing – www.wittenstein-cymex.com

^{a)} At max. 10 % F_{2QMax}

^{b)} Valid for standard clamping hub diameter

^{c)} Refers to center of the output shaft or flange

^{d)} Please reduce input speed at higher ambient temperatures

^{e)} Smooth shaft

View A

View B

Motor shaft diameter [mm]

1-stage

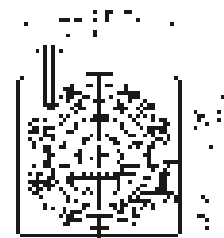
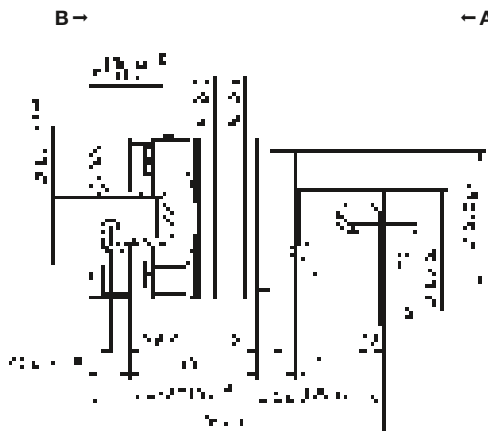
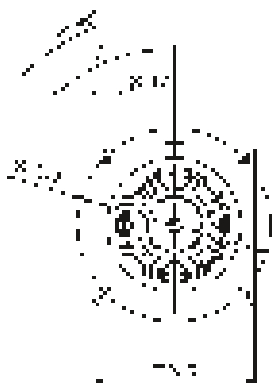
 up to 60⁴⁾ (O)⁵⁾
 clamping hub diameter

Planetary gearboxes

SP+

MC

Other output variants

Shaft with key

Splined shaft (DIN 5480)

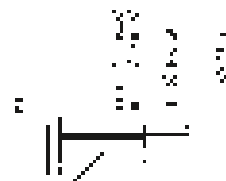
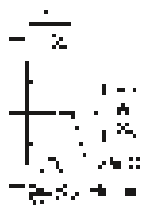
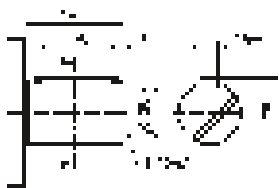

Non-tolerated dimensions are nominal dimensions

¹⁾ Check motor shaft fit

²⁾ Min./Max. permissible motor shaft length. Longer motor shafts are possible, please contact alpha.

³⁾ The dimensions depend on the motor

⁴⁾ Smaller motor shaft diameter is compensated by a bushing with a minimum thickness of 1 mm

⁵⁾ Standard clamping hub diameter

SP+ 240 MC 2-stage

				2-stage											
Ratio	<i>i</i>			16	20	25	28	32	35	40	50	64	70	100	
Max. torque ^{a) b) e)}	T_{2a}	<i>Nm</i>		3500	3500	3600	2900	2900	3600	1680	2100	1800	2700	1800	
		<i>in.lb</i>		30978	30978	31863	25667	25667	31863	14869	18587	15931	23897	15931	
Max. acceleration torque ^{b) e)} (max. 1000 cycles per hour)	T_{2B}	<i>Nm</i>		3500	3500	3600	2900	2900	3600	1680	2100	1800	2700	1800	
		<i>in.lb</i>		30978	30978	31863	25667	25667	31863	14869	18587	15931	23897	15931	
Nominal torque (at n_{1N})	T_{2N}	<i>Nm</i>		1950	1803	2266	1867	2320	2694	1344	1680	1440	2160	1440	
		<i>in.lb</i>		17255	15960	20058	16521	20534	23843	11895	14869	12745	19118	12745	
Emergency stop torque ^{a) b) e)} (permitted 1000 times during the service life of the gearbox)	T_{2Not}	<i>Nm</i>		8500	8500	8500	8500	8500	8500	8500	8500	6850	8500	6850	
		<i>in.lb</i>		75232	75232	75232	75232	75232	75232	75232	75232	75232	60628	75232	60628
Permitted average input speed (at T_{2a} and 20 °C ambient temperature) ^{d)}	n_{1N}	<i>rpm</i>		3500	4500	4500	4500	4500	4500	4500	4500	4500	4500	4500	
Max. input speed	n_{1Max}	<i>rpm</i>		6000	6000	6000	6000	6000	6000	6000	6000	6000	6000	6000	
Mean no load running torque ^{b)} (at $n_1 = 2000$ rpm and 20 °C gearbox temperature)	T_{012}	<i>Nm</i>		4.8	4.4	4.0	3.6	3.6	2.8	2.4	2.0	2.0	1.6	1.4	
		<i>in.lb</i>		43	39	35	32	32	25	21	18	18	14	13	
Max. backlash	j_t	<i>arcmin</i>		Standard ≤ 5 / Reduced ≤ 4											
Torsional rigidity ^{b)}	C_{121}	<i>Nm/arcmin</i>		550											
		<i>in.lb/arcmin</i>		4868											
Max. axial force ^{c)}	F_{2AMax}	<i>N</i>		33000											
		<i>lb_f</i>		7425											
Max. lateral force ^{c)}	F_{2QMax}	<i>N</i>		30000											
		<i>lb_f</i>		6750											
Max. tilting moment	M_{2KMax}	<i>Nm</i>		5000											
		<i>in.lb</i>		44254											
Efficiency at full load	η	%		96.5											
Service life	L_h	<i>h</i>		> 30000											
Weight (incl. standard adapter plate)	<i>m</i>	<i>kg</i>		76											
		<i>lb_m</i>		168.0											
Operating noise (at reference ratio and reference speed – ratio-specific values available in cymex [®])	L_{pA}	<i>dB(A)</i>		≤ 58											
Max. permitted housing temperature		°C		+90											
		<i>F</i>		194											
Ambient temperature		°C		-15 to +40											
		<i>F</i>		5 to 104											
Lubrication				Lubricated for life											
Direction of rotation				In- and output same direction											
Protection class				IP 65											
Metal bellows coupling (recommended product type – validate sizing with cymex [®])				BC2-04000AA085.000-X											
Bore diameter of coupling on the application side		<i>mm</i>		X = 050.000 - 090.000											
Mass moment of inertia (relates to the drive) Clamping hub diameter [mm]	M	48	J_1	<i>kgcm²</i>	34.5	31.5	30.8	30.0	30.0	29.7	28.5	28.3	28.3	28.1	28.0
				<i>10⁻³ in.lb.s²</i>	30.5	27.9	27.3	26.6	26.6	26.3	25.2	25.1	25.1	24.9	24.8

Please use our sizing software cymex[®] for a detailed sizing – www.wittenstein-cymex.com

- ^{a)} At max. 10 % F_{2QMax}
- ^{b)} Valid for standard clamping hub diameter
- ^{c)} Refers to center of the output shaft or flange
- ^{d)} Please reduce input speed at higher ambient temperatures
- ^{e)} Smooth shaft

View A

View B

Motor shaft diameter [mm]

2-stage

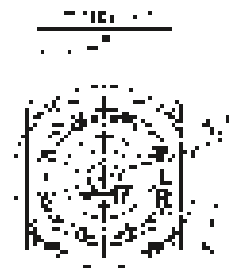
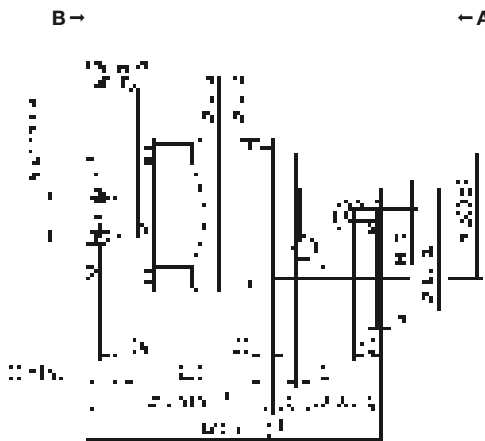
 up to 48⁴⁾ (M)⁵⁾
 clamping hub diameter

Planetary gearboxes

SP+

MC

Other output variants

Shaft with key

Splined shaft (DIN 5480)

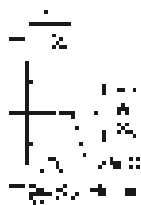
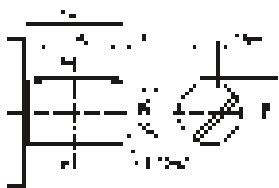

Non-tolerated dimensions are nominal dimensions

¹⁾ Check motor shaft fit

²⁾ Min./Max. permissible motor shaft length. Longer motor shafts are possible, please contact alpha.

³⁾ The dimensions depend on the motor

⁴⁾ Smaller motor shaft diameter is compensated by a bushing with a minimum thickness of 1 mm

⁵⁾ Standard clamping hub diameter